

Orbital Motors

Low Speed, High Torque Motors

BMR / BMRS

Series



TECH HYDRO - Orbital Motor Catalog BMR/BMRS Rev. A (31/01/2025)



TECH HYDRO

Power. Precision. Performance.

TABLE OF CONTENTS

DESCRIPTION	2-3	PERMISSIBLE SHAFT SEAL PRESSURES -	
Features	3	BMR, BMRS SERIES	19
Typical Applications	3	DIRECTION OF SHAFT ROTATION -	
BMR, BMRS, BMRWN Motor Cross Reference Guide	3	BMR, BMRS SERIES	20
		Permissible Shaft Loads for BMR, BMRS Series	20
TECHNICAL SPECIFICATIONS -		BMR DESIGNATION & ORDERING CODE	21
BMR, BMRS, BMRWN SERIES	4	BMRS DESIGNATION & ORDERING CODE	22
PERFORMANCE DATA - BMSY SERIES	5-10	BMRWN DIMENSIONS, PORT &	
BMR 36, BMR 50	5	MOUNTING DETAILS	23
BMR 80, BMR 100	6	BMRWN Port Details	23
BMR 125, BMR 150	7	BMRWN Mounting Flanges	23
BMR 200, BMR 250	8	BMRWN DESIGNATION & ORDERING CODE	24
BMR 315, BMR 375	9	BMR-BK01, BMRS-BK01, BMRWN-BK01	
BMR 500	10	MOTORS WITH INTEGRATED BRAKE	25
		Description & Function	25
BMR, BMRS PORTING CODE OVERVIEW	10	BMR-BK01, BMRS-BK01, BMRWN-BK01	
BMR DIMENSIONS, PORT &		DIMENSIONS, PORT & MOUNTING DETAILS	26
MOUNTING DETAILS	11	TECHNICAL SPECIFICATIONS -	
BMR Port Details	11	BMR BK01, BMRS-BK01, BMRWN-BK01	27
BMR Mounting Flanges	11	BMR-BK01 DESIGNATION	
BMR MOUNTING FLANGES	12	& ORDERING CODE	28
BMRS DIMENSIONS, PORT &		BMRS-BK01 DESIGNATION	
MOUNTING DETAILS	13	& ORDERING CODE	29
BMRS Port Details	11	BMRWN-BK01 DESIGNATION	
BMRS Mounting Flanges	11	& ORDERING CODE	30
BMRS MOUNTING FLANGES	14		
BMR SHAFT EXTENSIONS	15-16		
BMRS SHAFT EXTENSIONS	17-18		

DESCRIPTION

Techhydro BMR series motors, unlike the BMP series that utilizes a two-piece rotor design, are designed with seven precision rollers to provide sliding contact points. The rollers added to the lobes of the outer ring of the gear set act as a roller bearing and reduce friction, increasing mechanical efficiency and reducing wear in systems with low fluid viscosity, requiring lower pressure at start-up and providing smoother operation at all speeds. The drive link in these models receives full flow lubrication at all times. The sum of these features provides more power and longer life for the motor in your application.

Check valves integrated into the housing allow case pressure to drain internally. The robust high pressure shaft seals standard on all models can withstand high case pressure spikes. The BMR series motors have three moving components: geroler-star (fig. 3b), drive (fig. 2), and shaft (fig. 1) making them compact and highly efficient. A variety of displacements, mounts, shafts and port options provide design flexibility. The output shaft on BMR and BMRS can also be supported in needle bearings. These bearings allow a higher permissible radial load in comparison to our standard BMR and BMRS motors. They are an ideal choice for light duty applications in either parallel or series systems.

As well as the standard BMR and BMRS the BMRWN model offers wheel mount. In addition BMR-BK01, BMRS-BK01 and BMRWN-BK01 models are equipped with a fail-safe friction disk brake, where in the absence of system pressure the brake is engaged (see pages 25 to 30).

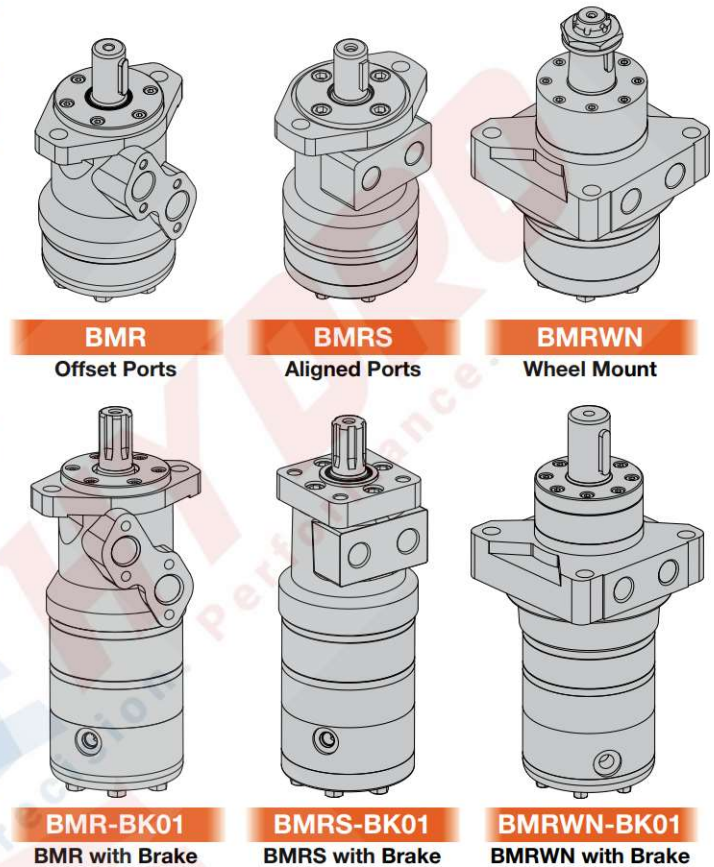

Standard Slide Bearings

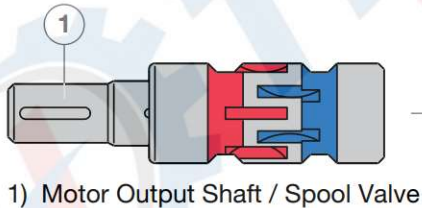

Optional Needle Bearings (Factory Order)

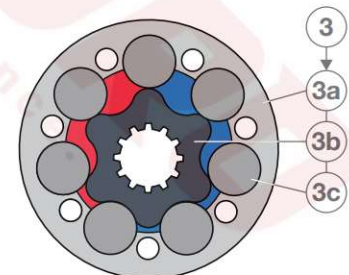
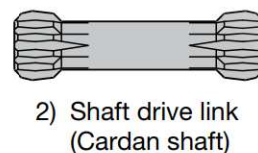
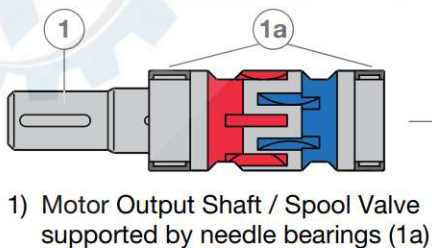

FEATURES

- "Roller Stator" motor design increases efficiency and life by using roller contact versus a solid, sliding contact design.
- Efficient, powerful and compact. Designed for light duty applications.
- Built-in check valves offer versatility and increased seal life.
- Variety of displacements, mounts and shafts provide flexibility in application design.
- Standard high pressure shaft seal offers superior seal life and performance.

TYPICAL APPLICATIONS

Agricultural equipment, food processing equipment, augers, car wash brushes, conveyors, grain augers, machine tools, sweepers, spreaders, skid steer attachments, feed rollers, brush drives and more.

BMR, BMRS, BMRWN MOTOR CROSS REFERENCE GUIDE

<i>Brand</i>	<i>Series</i>
Danfoss®	OMR, OMRW N, OMRW NF, DS
Eaton Char-Lynn®	S (103-)
White®	WP (155/156), RS (200/201), WR (255/256)
Parker®	TB, TC, TE
M&S®	MLHR, MR, MLHRW
ROSS-TRW®	MF
BREVINI - SAM®	BR, BS

TECHNICAL SPECIFICATIONS - BMR, BMRS, BMRWN SERIES

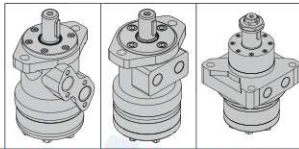

			1	2	3	4	5	6	7	8	9	10	11		
	BMR	BMRS	BMRWN	36	50	80	100	125	160	200	250	315	375	500*	
Geometric Displacement	in ³ /r			2.20	3.15	4.97	6.22	7.76	9.59	11.87	15.46	19.38	23.27	29.84	
	cm ³ /r			36.0	51.7	81.5	102.0	127.2	157.2	194.5	253.3	317.5	381.4	489.0	
Max. Speed	rpm	Cont.		1085	960	750	600	475	378	310	240	190	155	120	
		Inter.		1220	1150	940	750	600	475	385	300	240	190	150	
Max. Flow	gpm	Cont.		10.6	13.2	15.9	15.9	15.9	15.9	15.9	15.9	15.9	15.9	15.9	15.9
				40	50	60	60	60	60	60	60	60	60	60	60
	l/min	Inter.		11.9	15.9	19.8	19.8	19.8	19.8	19.8	19.8	19.8	19.8	19.8	19.8
				45	60	75	75	75	75	75	75	75	75	75	75
Max. Torque	lbf-ft	Cont.		53.1	73.8	143.8	177.0	221.3	265.5	265.5	287.6	287.6	309.8	-	
				72	100	195	240	300	360	360	390	390	420	-	
	Nm	Inter.		61.2	92.9	162.3	206.5	250.8	317.2	324.5	361.4	394.6	365.1	-	
				83	126	220	280	340	430	440	490	535	495	-	
Shaft extensions with diameters Ø 7/8", 1" Ø 25 mm, 28.5 mm	Peak	Peak		77.4	121.7	199.1	236.0	272.9	339.3	413.0	472.0	479.4	501.5	-	
				105	165	270	320	370	460	560	640	650	680	-	
	Max. Pressure Drop	Δ psi	Cont.		2031	2031	2538	2538	2538	2393	1885	1595	1305	1015	-
					140	140	175	175	175	165	130	110	90	85	-
Δ bar	Inter.	Inter.		2393	2538	2901	2901	2901	2901	2538	2176	1885	1450	-	
				165	175	200	200	200	200	175	150	130	100	-	
	Peak	Peak		3263	3263	3263	3263	3263	3263	3263	2901	2538	2176	-	
				225	225	225	225	225	225	225	225	200	175	150	
Max. Output	hp	Cont.		11.4	12.7	16.8	17.4	16.8	16.8	13.4	9.4	8.0	6.7	-	
				8.5	9.5	12.5	13.0	12.5	12.5	10.0	7.0	6.0	5.0	-	
	kW	Inter.		13.1	15.0	20.1	20.1	19.4	18.8	17.4	12.7	12.1	10.7	-	
				9.8	11.2	15.0	15.0	14.5	14.0	13.0	9.5	9.0	8.0	-	
Max. Torque	lbf-ft	Cont.		53.1	73.8	143.8	177.0	221.3	280.3	331.9	398.3	405.7	427.8	427.8	
				72	100	195	240	300	380	450	540	550	580	580	
	Nm	Inter.		61.2	92.9	162.3	206.5	250.8	317.2	368.8	449.9	508.9	508.9	508.9	
				83	126	220	280	340	430	500	610	690	690	690	
Shaft extensions with diameters Ø 1 1/4" Ø 32 mm, 35 mm	Peak	Peak		77.4	121.7	199.1	236.0	272.9	339.3	413.0	523.7	619.6	612.2	612.2	
				105	165	270	320	370	460	560	710	840	830	830	
	Max. Pressure Drop	Δ psi	Cont.		2031	2031	2538	2538	2538	2538	2538	2538	1958	1668	1450
					140	140	175	175	175	175	175	175	135	115	100
Δ bar	Inter.	Inter.		2393	2538	2901	2901	2901	2901	2901	2901	2538	2176	1740	
				165	175	200	200	200	200	200	200	175	150	120	
	Peak	Peak		3263	3263	3263	3263	3263	3263	3263	3263	3046	2538	2176	
				225	225	225	225	225	225	225	225	210	175	150	
Max. Output	hp	Cont.		11.4	12.7	16.8	17.4	16.8	16.8	14.8	13.4	12.1	10.1	10.1	
				8.5	9.5	12.5	13.0	12.5	12.5	11.0	10.0	9.0	7.5	7.5	
	kW	Inter.		13.1	15.0	20.1	20.1	19.4	18.8	17.4	16.1	13.4	12.1	12.1	
				9.8	11.2	15.0	15.0	14.5	14.0	13.0	12.0	10.0	9.0	9.0	
Weight	lbs		15.4	15.7	16.3	16.8	17.2	17.9	19.0	20.3	21.6	22.9	22.9		
	kg		7.0	7.1	7.4	7.6	7.8	8.1	8.6	9.2	9.8	10.4	10.4		

Notes:

- Continuous rating (Cont.): motor may be run continuously at these ratings.
- Intermittent operation (Inter.): 10% of every minute. (6 sec.)
- Peak: 1% of every minute. (0.6 sec.)

* 500 cc motor only offered on the BMR series with shaft extensions Ø 1-1/4", Ø 32 mm, 35 mm

- Δ Pressure: Δ psi [Δ bar] True pressure difference between inlet port and outlet port.
- Motor Power (HP) = (Torque Output (In. lbs.) x RPM) / 63025
- Simultaneous maximum torque & maximum speed NOT recommended and may damage the motor.

PERFORMANCE DATA - BMR, BMRS, BMRWN SERIES

Performance data is based on the geroler displacement and applies to all models. BMR, BMRS, BMRWN



BMR 36 2.2 in³/rev. (36 cm³/rev.)

Torque Speed	lbf.ft (Nm) rpm	Δ Pressure psi (bar) →						Max. Cont.	Max. Inter.	
		290 (20)	435 (30)	725 (50)	1015 (70)	1305 (90)	1450 (100)	1813 (125)	2031 (140)	2393 (165)
Flow gpm (l/min) ↓	1.1 (4)	7.4 (10) 105	11.8 (16) 100	18.4 (25) 92	27.3 (37) 80	33.9 (46) 71	36.9 (50) 58			
	2.1 (8)	6.6 (9) 208	11.1 (15) 200	18.4 (25) 188	27.3 (37) 175	34.7 (47) 158	36.9 (50) 149	46.5 (63) 134	52.4 (71) 120	61.2 (83) 108
	4.0 (15)	5.9 (8) 403	10.3 (14) 392	17.0 (23) 380	26.6 (36) 365	33.2 (45) 348	37.6 (51) 326	47.2 (64) 318	53.1 (72) 302	60.5 (82) 274
	5.3 (20)	4.4 (6) 540	9.6 (13) 531	16.2 (22) 518	25.8 (35) 500	32.5 (44) 483	36.9 (50) 462	47.2 (64) 450	53.1 (72) 435	60.5 (82) 412
	7.9 (30)	4.4 (6) 810	8.9 (12) 798	15.5 (21) 780	23.6 (32) 763	31.0 (42) 742	34.7 (47) 722	46.5 (63) 705	51.6 (70) 694	59.0 (80) 668
Max. Cont.	10.6 (40)	3.7 (5) 1092	8.1 (11) 1080	14.0 (19) 1069	22.1 (30) 1056	30.2 (41) 1042	33.2 (45) 1028	45.0 (61) 1011	50.2 (68) 984	58.3 (79) 957
Max. Inter.	11.9 (45)	3 (4) 1230	7.4 (10) 1215	12.5 (17) 1194	21.4 (29) 1170	29.5 (40) 1150	32.5 (44) 1128	43.5 (59) 1100	48.7 (66) 1070	56.8 (77) 1020

Continuous values

Intermittent values (max 10% operation every minute)



BMR 50 3.2 in³/rev. (51.7 cm³/rev.)

Torque Speed	lbf.ft (Nm) rpm	Δ Pressure psi (bar) →					Max. Cont.	Max. Inter.	
		725 (50)	1015 (70)	1305 (90)	1450 (100)	1740 (120)	2031 (140)	2321 (160)	2538 (175)
Flow gpm (l/min) ↓	1.3 (5)	25.8 (35) 93	33.2 (45) 84	45.0 (61) 76	49.4 (67) 73	56.8 (77) 69	64.9 (88) 46		
	2.6 (10)	26.6 (36) 186	33.9 (46) 178	45.7 (62) 166	50.9 (69) 162	59.0 (80) 153	70.1 (95) 136	79.7 (108) 118	88.5 (120) 97
	4.0 (15)	25.8 (35) 283	36.1 (49) 277	46.5 (63) 269	53.8 (73) 261	64.9 (88) 250	73.8 (100) 230	80.4 (109) 211	90.7 (123) 185
	5.3 (20)	25.4 (34.5) 377	34.7 (47) 375	45.0 (61) 365	50.9 (69) 361	61.2 (83) 346	70.8 (96) 330	80.4 (109) 302	92.9 (126) 270
	7.9 (30)	24.3 (33) 576	32.5 (44) 569	44.3 (60) 561	49.4 (67) 554	59.0 (80) 542	70.1 (95) 531	79.7 (108) 500	92.9 (126) 465
	10.6 (40)	22.1 (30) 760	30.2 (41) 758	42.8 (58) 753	48.7 (66) 750	58.3 (79) 738	67.9 (92) 724	78.2 (106) 700	90.0 (122) 670
	11.9 (45)	21.8 (29.5) 856	29.5 (40) 853	42.0 (57) 849	47.9 (65) 845	57.5 (78) 835	66.4 (90) 815	77.4 (105) 796	89.2 (121) 770
Max. Cont.	13.2 (50)	19.2 (26) 950	27.3 (37) 940	39.1 (53) 925	44.3 (60) 906	53.8 (73) 880	62.7 (85) 852	73.0 (99) 832	84.1 (114) 801
Max. Inter.	15.9 (60)	14.8 (20) 1138	24.3 (33) 1124	35.4 (48) 1100	41.3 (56) 1075	50.9 (69) 1056	59.7 (81) 1028	70.1 (95) 1006	80.4 (109) 970

Continuous values

Intermittent values (max 10% operation every minute)

Motors run with high efficiency in all areas until maximum continuous values are exceeded. For best service life of the motor select a motor to run with a torque and speed range printed in the light shaded area. Simultaneous maximum torque and maximum speed NOT recommended and may damage the motor.

Performance data is typical of randomly selected motors at back pressure of 72.5 to 145 psi [5 to 10 bar] and oil with viscosity of 32 mm²/s [150 SUS] at 50°C [122 F].

Actual data may vary slightly from one production motor to another.

TECHYDRO Orbital Motor Catalog BMR/BMRS Rev. A (31/01/2025)

PERFORMANCE DATA - BMR, BMRS, BMRWN SERIES
BMR 80

 5.0 in³/rev. (81.5 cm³/rev.)

Performance data is based on the geroler displacement and applies to all models. BMR, BMRS, BMRWN



Torque Speed	lbf.ft (Nm) rpm	Δ Pressure psi (bar) →					Max. Cont.		Max. Inter.	
		725 (50)	1015 (70)	1305 (90)	1450 (100)	1740 (120)	2031 (140)	2321 (160)	2538 (175)	2901 (200)
Flow gpm (l/min) ↓	1.3 (5)	36.9 (50) 59	47.2 (64) 56	64.9 (88) 50	79.7 (108) 44	98.1 (133) 38				
	2.6 (10)	39.8 (54) 118	56.8 (77) 113	73.0 (99) 106	79.7 (108) 97	95.1 (129) 86	110.6 (150) 79	127.6 (173) 56		
	5.3 (20)	42.0 (57) 238	57.5 (78) 234	75.2 (102) 227	81.9 (111) 216	98.8 (134) 203	114.3 (155) 190	130.5 (177) 178	144.6 (196) 154	166.0 (225) 135
	7.9 (30)	39.8 (54) 360	55.3 (75) 352	73.8 (100) 340	79.7 (108) 332	96.6 (131) 316	112.1 (152) 302	129.8 (176) 290	143.8 (195) 274	164.5 (223) 250
	10.6 (40)	35.4 (48) 480	53.8 (73) 470	70.8 (96) 458	77.4 (105) 445	93.7 (127) 430	109.2 (148) 418	126.9 (172) 403	140.1 (190) 388	162.3 (220) 359
	13.2 (50)	31.0 (42) 604	51.6 (70) 595	68.6 (93) 582	75.2 (102) 570	91.5 (124) 556	108.4 (147) 540	125.4 (170) 521	138.7 (188) 504	160.8 (218) 487
Max. Cont.	15.9 (60)	27.3 (37) 726	48.7 (66) 715	65.6 (89) 704	72.3 (98) 692	89.2 (121) 678	106.2 (144) 663	122.4 (166) 647	135.7 (184) 622	157.1 (213) 594
	18.5 (70)	23.6 (32) 845	44.3 (60) 834	61.2 (83) 820	70.1 (95) 802	85.6 (116) 789	103.3 (140) 767	118.0 (160) 754	130.5 (177) 730	153.4 (208) 705
Max. Inter.	19.8 (75)	15.5 (21) 910	36.9 (50) 895	57.5 (78) 881	66.4 (90) 867	81.9 (111) 852	99.6 (135) 830	113.6 (154) 806	126.1 (171) 787	147.5 (200) 756

 Continuous values

 Intermittent values (max 10% operation every minute)

BMR 100

 6.2 in³/rev. (102 cm³/rev.)

Torque Speed	lbf.ft (Nm) rpm	Δ Pressure psi (bar) →					Max. Cont.		Max. Inter.	
		725 (50)	1015 (70)	1305 (90)	1450 (100)	1740 (120)	2031 (140)	2321 (160)	2538 (175)	2901 (200)
Flow gpm (l/min) ↓	1.3 (5)	48.7 (66) 45	67.9 (92) 42	88.5 (120) 38	99.6 (135) 34	115.1 (156) 27				
	2.6 (10)	50.2 (68) 93	70.8 (96) 90	92.2 (125) 86	101.8 (138) 81	117.3 (159) 74	138.7 (188) 57	156.4 (212) 42		
	5.3 (20)	47.9 (65) 189	69.3 (94) 185	90.7 (123) 180	101.0 (137) 173	114.3 (155) 165	137.2 (186) 158	154.9 (210) 150	175.5 (238) 139	202.1 (274) 118
	7.9 (30)	46.5 (63) 286	67.9 (92) 281	88.5 (120) 275	98.1 (133) 266	112.8 (153) 257	136.4 (185) 246	154.2 (209) 237	173.3 (235) 225	199.1 (270) 207
	10.6 (40)	42.0 (57) 385	64.9 (88) 378	86.3 (117) 365	95.9 (130) 355	112.1 (152) 345	136.4 (185) 332	153.4 (208) 320	171.9 (233) 314	196.9 (267) 297
	13.2 (50)	35.4 (48) 482	58.3 (79) 477	81.1 (110) 470	90.7 (123) 460	110.6 (150) 448	135.0 (183) 435	150.5 (204) 420	168.2 (228) 405	191.8 (260) 389
Max. Cont.	15.9 (60)	28.0 (38) 580	51.6 (70) 572	77.4 (105) 560	88.5 (120) 548	106.2 (144) 535	131.3 (178) 523	147.5 (200) 510	162.3 (220) 500	185.9 (252) 478
	18.5 (70)	23.6 (32) 678	47.9 (65) 670	73.8 (100) 660	87.0 (118) 648	104.0 (141) 638	129.8 (176) 626	145.3 (197) 615	158.6 (215) 606	181.4 (246) 580
Max. Inter.	19.8 (75)	17.0 (23) 728	43.5 (59) 720	68.6 (93) 710	81.9 (111) 695	100.3 (136) 681	125.4 (170) 667	141.6 (192) 650	154.9 (210) 634	177.0 (240) 618

 Continuous values

 Intermittent values (max 10% operation every minute)

Motors run with high efficiency in all areas until maximum continuous values are exceeded. For best service life of the motor select a motor to run with a torque and speed range printed in the light shaded area. Simultaneous maximum torque and maximum speed NOT recommended and may damage the motor.

Performance data is typical of randomly selected motors at back pressure of 72.5 to 145 psi [5 to 10 bar] and oil with viscosity of 32 mm²/s [150 SUS] at 50°C [122 F].

Actual data may vary slightly from one production motor to another.

PERFORMANCE DATA - BMR, BMRS, BMRWN SERIES

BMR 125 7.8 in³/rev. (127.2 cm³/rev.)

Performance data is based on the geroler displacement and applies to all models. BMR, BMRS, BMRWN



Torque Speed	lbf.ft (Nm) rpm	Δ Pressure psi (bar) →					Max. Cont.		Max. Inter.	
		725 (50)	1015 (70)	1305 (90)	1450 (100)	1740 (120)	2031 (140)	2321 (160)	2538 (175)	2901 (200)
Flow gpm (l/min) ↓	1.3 (5)	56.1 (79) 36	81.1 (110) 31	106.9 (145) 25	123.2 (167) 19	139.4 (189) 13				
	2.6 (10)	62.0 (84) 73	87.0 (118) 70	114.3 (155) 60	129.8 (176) 48	149.0 (202) 36	168.2 (228) 25	186.6 (253) 19		
	5.3 (20)	60.5 (82) 153	86.3 (117) 151	112.8 (153) 148	128.3 (174) 144	147.5 (200) 138	169.6 (230) 128	191.0 (259) 117	216.8 (294) 104	244.9 (332) 73
	7.9 (30)	58.3 (79) 231	85.6 (116) 228	111.4 (151) 224	126.1 (171) 218	146.0 (198) 210	168.2 (228) 201	189.6 (257) 183	215.4 (292) 168	242.7 (329) 137
	10.6 (40)	53.1 (72) 309	84.1 (114) 307	109.2 (148) 303	123.9 (168) 298	144.6 (196) 292	166.7 (226) 280	188.8 (256) 270	213.9 (290) 252	241.2 (327) 218
	13.2 (50)	45.7 (62) 389	77.4 (105) 386	105.5 (143) 382	121.7 (165) 378	143.8 (195) 370	164.5 (223) 360	187.3 (254) 344	211.7 (287) 328	238.2 (323) 292
Max. Cont.	15.9 (60)	38.4 (52) 467	72.3 (98) 463	100.3 (136) 459	118.0 (160) 456	140.9 (191) 448	162.3 (220) 427	184.4 (250) 410	208.0 (282) 399	235.3 (319) 352
Inter.	18.5 (70)	30.2 (41) 545	66.4 (90) 542	95.9 (130) 538	115.1 (156) 534	137.9 (187) 529	158.6 (215) 520	178.5 (242) 508	205.0 (278) 486	230.9 (313) 430
Max. Inter.	19.8 (75)	23.6 (32) 586	58.3 (79) 583	92.9 (126) 578	109.2 (148) 570	132.8 (180) 560	153.4 (208) 546	172.6 (234) 532	193.2 (262) 520	221.3 (300) 480

Continuous values Intermittent values (max 10% operation every minute)

BMR 160 9.6 in³/rev. (157.2 cm³/rev.)



Torque Speed	lbf.ft (Nm) rpm	Δ Pressure psi (bar) →					Max. Cont.		Max. Inter.	
		725 (50)	1015 (70)	1305 (90)	1450 (100)	1740 (120)	2031 (140)	2321 (160)	2538 (175)	2901 (200)
Flow gpm (l/min) ↓	1.3 (5)	76.7 (104) 26	107.7 (146) 23	140.1 (190) 20	154.9 (210) 16	180.7 (245) 10				
	2.6 (10)	78.9 (107) 59	110.6 (150) 56	143.8 (195) 50	159.3 (216) 45	184.4 (250) 37	213.9 (290) 30	247.1 (335) 22		
	5.3 (20)	75.2 (102) 121	111.4 (151) 118	146.0 (198) 115	162.3 (220) 113	189.6 (257) 108	219.8 (298) 102	252.2 (342) 97	272.9 (370) 90	309.8 (420) 78
	7.9 (30)	71.5 (97) 184	107.7 (146) 178	140.. (190) 173	160.1 (217) 170	188.8 (256) 164	217.6 (295) 155	250.8 (340) 143	271.4 (368) 128	306.8 (416) 103
	10.6 (40)	65.6 (89) 246	103.3 (140) 241	136.4 (185) 235	154.9 (210) 228	185.9 (252) 220	213.9 (290) 210	247.1 (335) 194	267.7 (363) 177	303.9 (412) 150
	13.2 (50)	53.1 (72) 310	94.4 (128) 307	132.0 (179) 300	149.0 (202) 295	180.0 (244) 287	209.5 (284) 278	241.2 (327) 262	264.0 (358) 247	301.7 (409) 210
Max. Cont.	15.9 (60)	44.3 (60) 374	85.6 (116) 367	125.4 (170) 359	146.0 (198) 354	177.0 (240) 346	205.8 (279) 338	236.8 (321) 323	259.6 (352) 306	295.0 (400) 265
Inter.	18.5 (70)	36.1 (49) 437	78.9 (107) 430	121.0 (164) 421	142.3 (193) 415	171.9 (233) 403	199.9 (271) 393	227.9 (309) 381	253.7 (344) 365	287.6 (390) 318
Max. Inter.	19.8 (75)	26.5 (36) 472	72.3 (98) 463	112.1 (152) 450	136.4 (185) 441	166.7 (226) 431	195.5 (265) 420	221.3 (300) 405	246.3 (334) 389	279.5 (379) 365

Continuous values Intermittent values (max 10% operation every minute)

Motors run with high efficiency in all areas until maximum continuous values are exceeded. For best service life of the motor select a motor to run with a torque and speed range printed in the light shaded area. Simultaneous maximum torque and maximum speed NOT recommended and may damage the motor.

Performance data is typical of randomly selected motors at back pressure of 72.5 to 145 psi [5 to 10 bar] and oil with viscosity of 32 mm²/s [150 SUS] at 50°C [122 F].

Actual data may vary slightly from one production motor to another.

TECHYDRO Orbital Motor Catalog BMR/BMRS Rev. A (31/01/2025)

PERFORMANCE DATA - BMR, BMRS, BMRWN SERIES
BMR 200 11.9 in³/rev. (194.5 cm³/rev.)

Performance data is based on the geroler displacement and applies to all models. BMR, BMRS, BMRWN



Torque Speed	lbf.ft (Nm) rpm	Δ Pressure psi (bar) →					Max. Cont.		Max. Inter.	
		725 (50)	1015 (70)	1305 (90)	1450 (100)	1740 (120)	2031 (140)	2321 (160)	2538 (175)	2901 (200)
Flow gpm (l/min) ↓	1.3 (5)	97.4 (132) 24	133.5 (181) 22	175.5 (238) 18	193.2 (262) 13	228.6 (310) 10				
	2.6 (10)	99.6 (135) 49	137.2 (186) 47	177.0 (240) 45	194.7 (264) 43	232.3 (315) 38	262.6 (356) 33	297.2 (403) 24		
	5.3 (20)	96.6 (131) 99	135.0 (183) 97	175.5 (238) 94	191.8 (260) 92	231.6 (314) 88	264.0 (358) 83	298.0 (404) 74	323.1 (438) 64	367.3 (498) 56
	7.9 (30)	92.9 (126) 149	131.3 (178) 147	171.9 (233) 144	187.3 (254) 141	229.4 (311) 135	261.8 (355) 126	296.5 (402) 113	317.9 (431) 105	358.5 (486) 91
	10.6 (40)	82.6 (112) 200	124.6 (169) 197	168.2 (228) 194	184.4 (250) 191	226.4 (307) 185	259.6 (352) 174	295.0 (400) 160	314.2 (426) 151	351.8 (477) 127
Max. Cont.	15.9 (60)	57.5 (78) 304	106.9 (145) 301	157.1 (213) 298	175.5 (238) 294	213.2 (289) 286	252.2 (342) 276	284.7 (386) 262	303.9 (412) 243	338.5 (459) 218
	18.5 (70)	49.4 (67) 355	99.6 (135) 353	151.9 (206) 349	168.2 (228) 340	204.3 (277) 329	247.8 (336) 316	276.6 (375) 300	300.9 (408) 288	334.1 (453) 257
Max. Inter.	19.8 (75)	42.8 (58) 382	92.2 (125) 379	145.3 (197) 373	162.3 (220) 362	199.1 (270) 350	236.8 (321) 337	265.5 (360) 322	293.5 (398) 312	326.0 (442) 278

 Continuous values

 Intermittent values (max 10% operation every minute)

BMR 250 15.5 in³/rev. (253.5 cm³/rev.)

Torque Speed	lbf.ft (Nm) rpm	Δ Pressure psi (bar) →					Max. Cont.		Max. Inter.	
		725 (50)	1015 (70)	1305 (90)	1450 (100)	1740 (120)	2031 (140)	2321 (160)	2538 (175)	2901 (200)
Flow gpm (l/min) ↓	1.3 (5)	129.1 (175) 17	179.2 (243) 16	224.2 (304) 14	252.2 (342) 12	300.2 (407) 10				
	2.6 (10)	131.3 (178) 37	181.4 (246) 35	228.6 (310) 31	253.7 (344) 28	301.7 (409) 23	343.0 (465) 18	387.2 (525) 11		
	5.3 (20)	129.1 (175) 75	180.0 (244) 73	227.2 (308) 72	250.8 (340) 70	300.9 (408) 66	341.5 (463) 58	383.5 (520) 53	411.6 (558) 50	469.1 (636) 42
	7.9 (30)	119.5 (162) 114	173.3 (235) 111	224.2 (304) 108	244.9 (332) 106	295.0 (400) 100	335.6 (455) 92	380.6 (516) 83	405.7 (550) 77	458.0 (621) 65
	10.6 (40)	105.5 (143) 154	164.5 (223) 152	221.3 (300) 150	242.7 (329) 147	292.1 (396) 143	329.7 (447) 132	377.6 (512) 120	402.7 (546) 110	455.1 (617) 90
Max. Cont.	15.9 (60)	76.0 (103) 233	141.6 (192) 230	206.5 (280) 227	231.6 (314) 224	273.6 (371) 218	314.2 (426) 205	360.7 (489) 190	379.1 (514) 181	426.3 (578) 155
	18.5 (70)	64.9 (88) 273	131.3 (178) 270	194.7 (264) 267	222.0 (301) 263	262.6 (356) 252	308.3 (418) 242	353.3 (479) 226	367.3 (498) 209	413.0 (560) 173
Max. Inter.	19.8 (75)	45.7 (62) 294	121.7 (165) 291	188.8 (256) 287	212.4 (288) 283	255.9 (347) 274	303.9 (412) 263	349.6 (474) 249	358.5 (486) 236	399.8 (542) 211

 Continuous values

 Intermittent values (max 10% operation every minute)

Motors run with high efficiency in all areas until maximum continuous values are exceeded. For best service life of the motor select a motor to run with a torque and speed range printed in the light shaded area. Simultaneous maximum torque and maximum speed NOT recommended and may damage the motor.

 Performance data is typical of randomly selected motors at back pressure of 72.5 to 145 psi [5 to 10 bar] and oil with viscosity of 32 mm²/s [150 SUS] at 50°C [122 F].

Actual data may vary slightly from one production motor to another.

PERFORMANCE DATA - BMR, BMRS, BMRWN SERIES

BMR 315 19.4 in³/rev. (317.5 cm³/rev.)

Performance data is based on the geroler displacement and applies to all models. BMR, BMRS, BMRWN

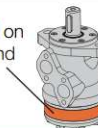

Torque Speed	lbf.ft (Nm) rpm	Δ Pressure psi (bar) →				Max. Cont.		Max. Inter.	
		725 (50)	1015 (70)	1305 (90)	1450 (100)	1740 (120)	2031 (140)	2321 (160)	2538 (175)
Flow gpm (l/min) ↓	1.3 (5)	158.6 (215) 13	222.7 (302) 11						
	2.6 (10)	160.8 (218) 28	225.0 (305) 27	282.5 (383) 25	311.3 (422) 24	359.9 (488) 21	406.4 (551) 18	458.8 (622) 13	
	5.3 (20)	158.6 (215) 60	223.5 (303) 59	280.3 (380) 57	308.3 (418) 55	357.7 (485) 52	404.9 (549) 49	457.3 (620) 45	486.5 (660) 42
	7.9 (30)	150.5 (204) 91	218.3 (296) 89	276.6 (375) 86	304.6 (413) 84	354.0 (480) 81	399.8 (542) 78	452.1 (613) 72	482.4 (654) 67
	10.6 (40)	144.6 (196) 122	211.7 (287) 120	271.4 (368) 117	302.4 (410) 112	351.8 (477) 106	397.5 (539) 100	449.2 (609) 94	479.4 (650) 85
	13.2 (50)	129.8 (176) 154	199.1 (270) 151	262.6 (356) 147	289.9 (393) 140	340.0 (461) 131	388.0 (526) 120	440.3 (597) 109	475.7 (645) 100
	Max. Cont. 15.9 (60)	119.5 (162) 185	181.4 (246) 182	250.0 (339) 177	275.8 (374) 172	329.0 (446) 163	376.9 (511) 152	432.2 (586) 140	463.2 (628) 134
	18.5 (70)	105.5 (143) 217	173.3 (235) 213	239.0 (324) 208	264.0 (358) 201	317.2 (430) 190	363.6 (493) 178	414.5 (562) 166	452.9 (614) 138
	Max. Inter. 19.8 (75)	92.2 (125) 232	156.4 (212) 228	223.5 (303) 222	250.0 (339) 216	307.6 (417) 208	354.8 (481) 200	400.5 (543) 183	429.3 (582) 171

Continuous values

Intermittent values (max 10% operation every minute)

BMR 375 23.3 in³/rev. (381.4 cm³/rev.)



Torque Speed	lbf.ft (Nm) rpm	Δ Pressure psi (bar) →				Max. Cont.		Max. Inter.	
		435 (30)	653 (45)	798 (55)	943 (65)	1160 (80)	1450 (100)	1813 (125)	2031 (140)
Flow gpm (l/min) ↓	1.3 (5)	112.8 (153) 12	171.1 (232) 10						
	2.6 (10)	115.8 (157) 24	174.1 (236) 23	209.5 (284) 22	248.6 (337) 21	299.4 (406) 19	366.6 (497) 17	451.4 (612) 15	492.7 (668) 12
	5.3 (20)	110.6 (150) 49	171.1 (232) 48	206.5 (280) 47	244.9 (332) 46	295.8 (401) 44	361.4 (490) 41	447.0 (606) 38	489.8 (660) 32
	7.9 (30)	104.7 (142) 76	158.6 (215) 75	202.1 (274) 74	241.2 (327) 73	293.5 (398) 71	356.2 (483) 67	444.7 (603) 63	480.9 (652) 50
	10.6 (40)	92.9 (126) 103	156.4 (212) 101	197.7 (268) 99	236.0 (320) 97	289.9 (393) 95	351.8 (477) 92	437.4 (593) 88	468.4 (635) 70
	13.2 (50)	77.4 (105) 128	137.9 (187) 126	178.5 (242) 124	222.7 (302) 121	277.3 (376) 118	335.6 (455) 115	430.0 (583) 111	448.4 (608) 96
	Max. Cont. 15.9 (60)	66.4 (90) 154	123.2 (167) 152	168.9 (229) 150	207.3 (281) 148	267.0 (362) 145	327.5 (444) 138	417.5 (566) 130	442.5 (600) 121
	18.5 (70)	66.4 (90) 180	109.9 (149) 179	147.5 (200) 178	190.3 (258) 176	251.5 (341) 173	313.5 (425) 168	402.7 (549) 160	427.8 (580) 148
	Max. Inter. 19.8 (75)	41.3 (56) 195	92.2 (125) 194	134.2 (182) 193	177.8 (241) 191	236.0 (320) 189	300.9 (408) 185	386.5 (524) 178	416.7 (565) 170

Continuous values

Intermittent values (max 10% operation every minute)

Motors run with high efficiency in all areas until maximum continuous values are exceeded. For best service life of the motor select a motor to run with a torque and speed range printed in the light shaded area. Simultaneous maximum torque and maximum speed NOT recommended and may damage the motor.

Performance data is typical of randomly selected motors at back pressure of 72.5 to 145 psi [5 to 10 bar] and oil with viscosity of 32 mm²/s [150 SUS] at 50°C [122 F].

Actual data may vary slightly from one production motor to another.

TECHYDRO Orbital Motor Catalog BMR/BMRS Rev. A (31/01/2025)

PERFORMANCE DATA - BMR, BMRS, BMRWN SERIES

BMR 500* 29.8 in³/rev. (489 cm³/rev.)

Performance data is based on the geroler displacement and applies to all models. BMR, BMRS, BMRWN



Torque Speed	lb.ft (Nm) rpm	Δ Pressure psi (bar) →				Max. Cont.	Max. Inter.
		435 (30)	653 (45)	870 (60)	1160 (80)	1450 (100)	1740 (120)
Flow	2.6 (10)	141.6 (192)	210.9 (286)	280.3 (380)	372.5 (505)	457.3 (620)	542.1 (735)
	5.3 (20)	143.8 (195)	216.1 (293)	284.7 (386)	377.6 (512)	461.0 (625)	545.8 (740)
	7.9 (30)	137.2 (186)	221.3 (300)	291.3 (395)	383.5 (520)	467.6 (634)	551.7 (748)
	10.5 (40)	125.4 (170)	221.3 (300)	287.6 (390)	387.2 (525)	472.0 (640)	556.9 (755)
Max. Cont.	13.2 (50)	116.5 (158)	213.9 (290)	281.7 (382)	379.8 (515)	464.7 (630)	550.2 (746)
	15.9 (60)	104.7 (142)	191.8 (260)	269.2 (365)	368.8 (500)	448.4 (608)	538.4 (730)
	18.5 (70)	92.2 (125)	180.7 (245)	250.8 (340)	355.5 (482)	433.7 (588)	520.7 (706)
Max. Inter.	19.8 (75)	76.7 (104)	166.7 (226)	237.5 (322)	343.0 (465)	418.9 (568)	506.0 (686)

☐ Continuous values

▒ Intermittent values (max 10% operation every minute)

*500 cc motor only offered on the BMR models with shaft extensions Ø 1-1/4", 32 mm, 35 mm.

Motors run with high efficiency in all areas until maximum continuous values are exceeded. For best service life of the motor select a motor to run with a torque and speed range printed in the light shaded area. Simultaneous maximum torque and maximum speed NOT recommended and may damage the motor. Performance data is typical of randomly selected motors at back pressure of 72.5 to 145 psi [5 to 10 bar] and oil with viscosity of 32 mm²/s [150 SUS] at 50°C [122 F]. Actual data may vary slightly from one production motor to another.

BMR/BMRS PORTING CODE OVERVIEW

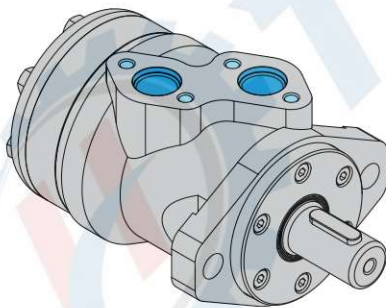

BMR
Line/Manifold Mount (Offset)
S, P, D, R, M

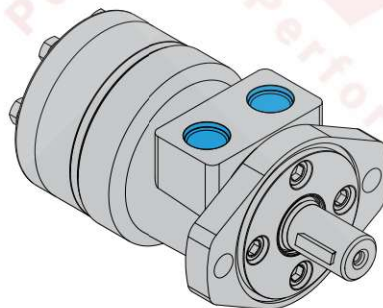

BMRS
Line Mount (Aligned)
S, P, G, R, M1, M2, M3

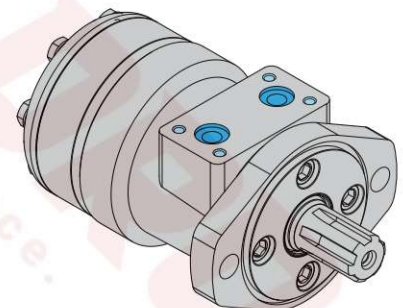

BMRS
Manifold Mount (Aligned)
B4, B5

BMR DIMENSIONS, PORT & MOUNTING DETAILS

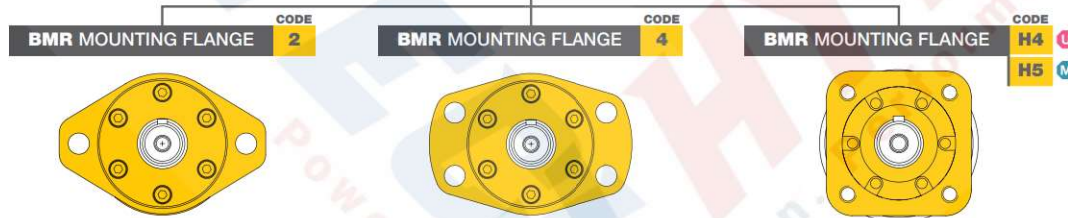
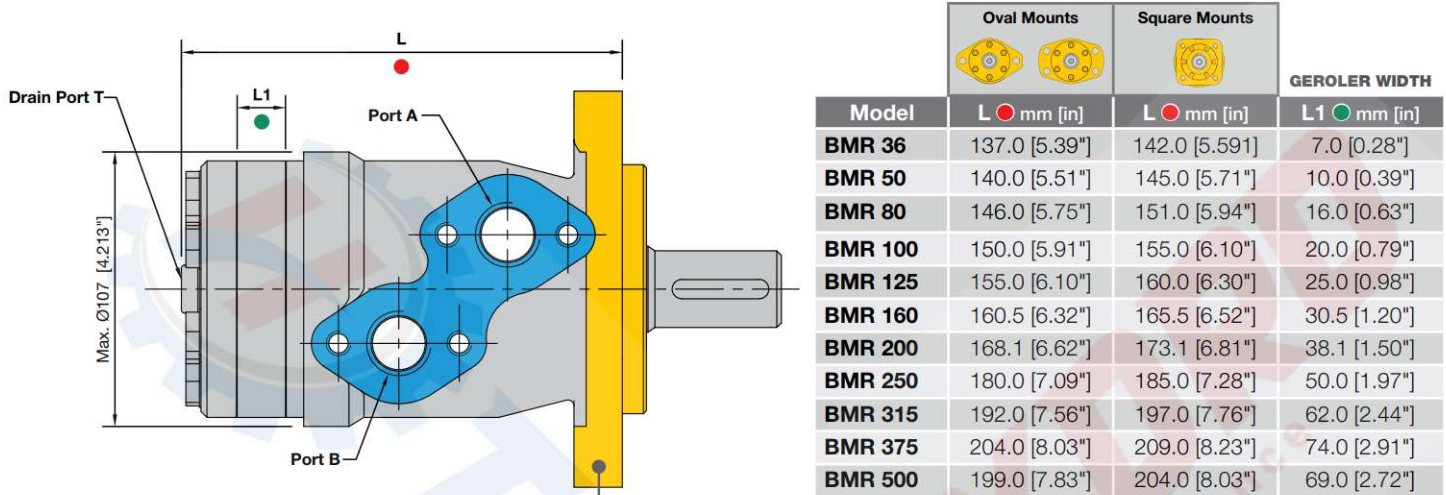

BMR PORT S P D R M
Line/Manifold Mount

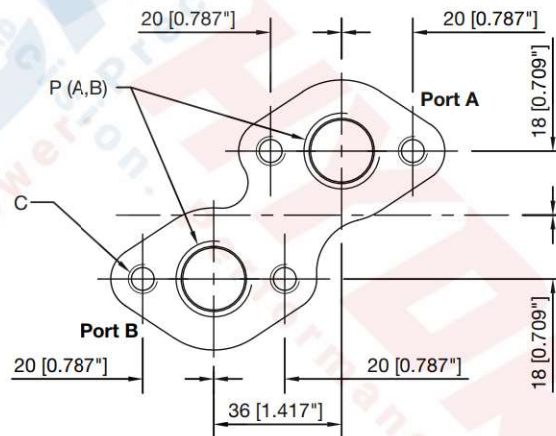
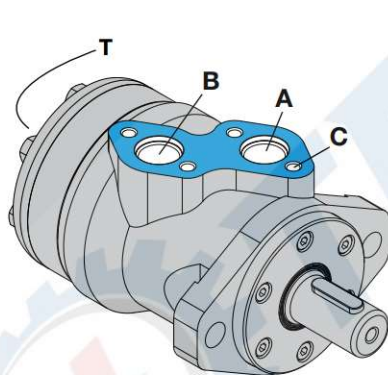

Connection	BMR PORT CODE				
	S	P	D	R	M
P (A,B)	7/8-14 UNF (17)	1/2-14 NPTF (15)	G 1/2" (15)	Rc 1/2" (15)	M22x1.5 (15) M
T	7/16-20 UNF (12)	7/16-20 UNF (12)	G 1/4" (12)	Rc 1/4" (9.7)	M14x1.5 (12) M
C (4x)	5/16-18 UNC (13) U	5/16-18 UNC (13) U	M8 (13) M	M8 (13) M	M8 (13) M

S: SAE straight thread (O-Ring Boss)
P: NPTF (National Pipe Tapered Fuel)
D: BSPP (British Standard Pipe Parallel) G thread
R: BSPT (British Standard Pipe Taper) Rc thread
M: Metric port

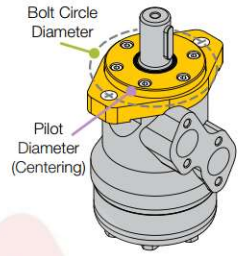

BMR MOUNTING FLANGE **CODE 2**

2-Bolt, SAE A Mount

- Pilot Diameter: 3.25"
- Bolt Circle Diameter: 4.19"

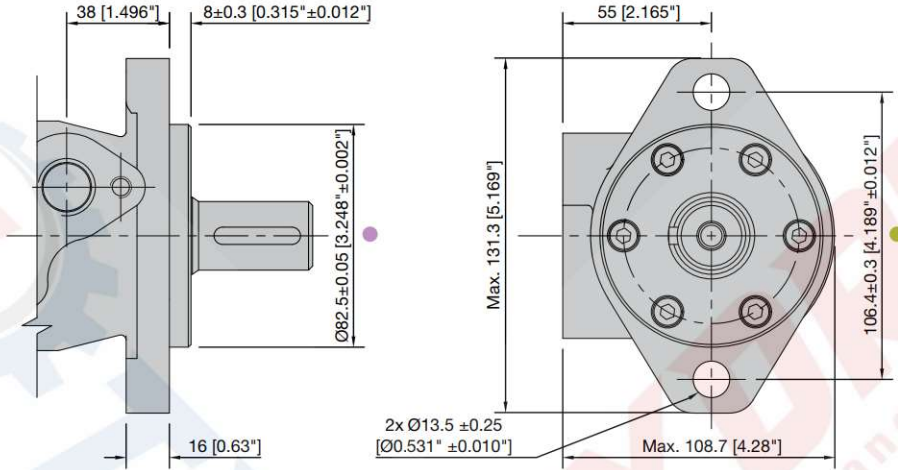

BMR MOUNTING FLANGE **CODE 4**

4-Bolt, Magneto Mount

- Pilot Diameter: 3.25"
- Bolt Circle Diameter: 4.19"

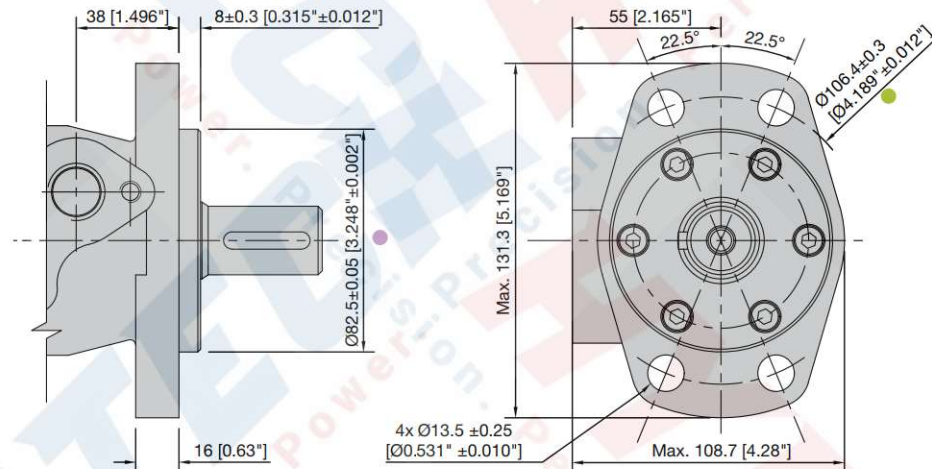

BMR MOUNTING FLANGE **CODE H4 U** **CODE H5 M**

4-Bolt, Square Mount

- Pilot Diameter: 1.75"
- Bolt Circle Diameter: 3.25"

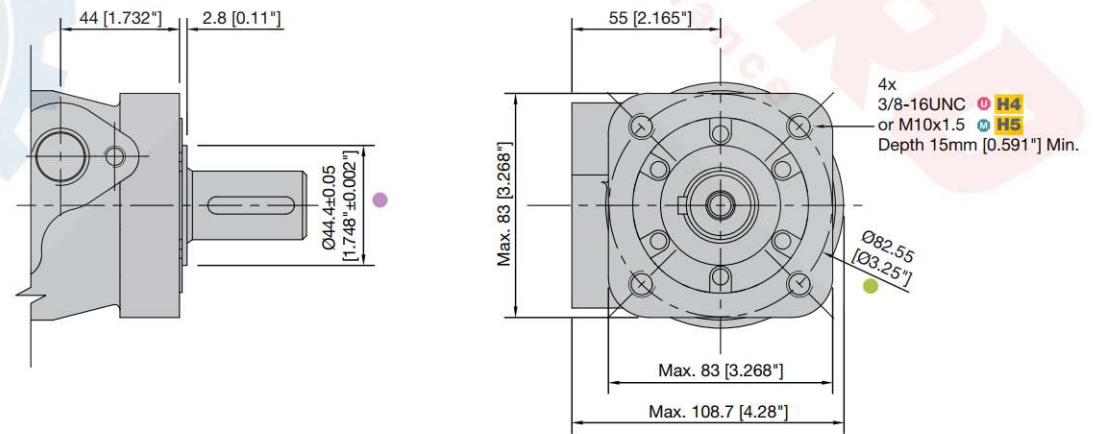

mm [inch] ● Pilot Diameter
 U Imperial M Metric ● Bolt Circle Diameter

BMRS DIMENSIONS, PORT & MOUNTING DETAILS

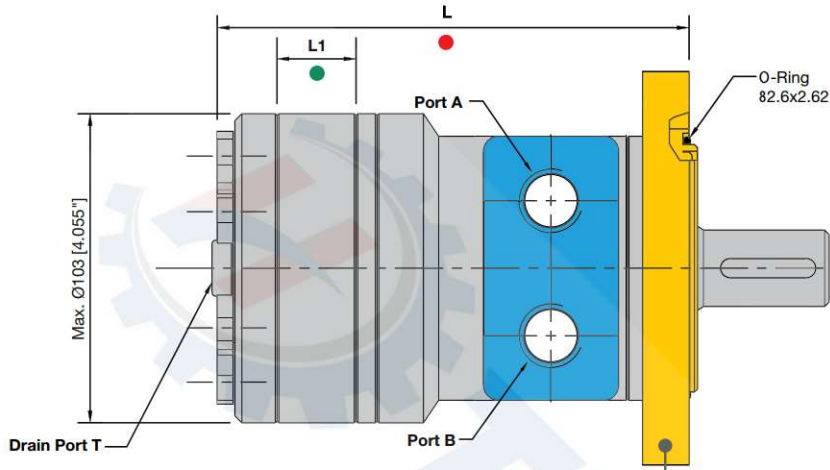

Model	GEROLER WIDTH	
	L ●	L1 ●
BMRS 36	143.0 [5.63"]	7.0 [0.28"]
BMRS 50	146.0 [5.75"]	10.0 [0.39"]
BMRS 80	152.0 [5.98"]	16.0 [0.63"]
BMRS 100	156.0 [6.14"]	20.0 [0.79"]
BMRS 125	161.0 [6.34"]	25.0 [0.98"]
BMRS 160	166.5 [6.56"]	30.5 [1.20"]
BMRS 200	174.0 [6.85"]	38.1 [1.50"]
BMRS 250	186.0 [7.32"]	50.0 [1.97"]
BMRS 315	198.0 [7.80"]	62.0 [2.44"]
BMRS 375	210.0 [8.27"]	74.0 [2.91"]



BMRS PORT Line Mount S P G R M1 M2 M3

BMRS PORT Manifold Mount B4 U B5 M

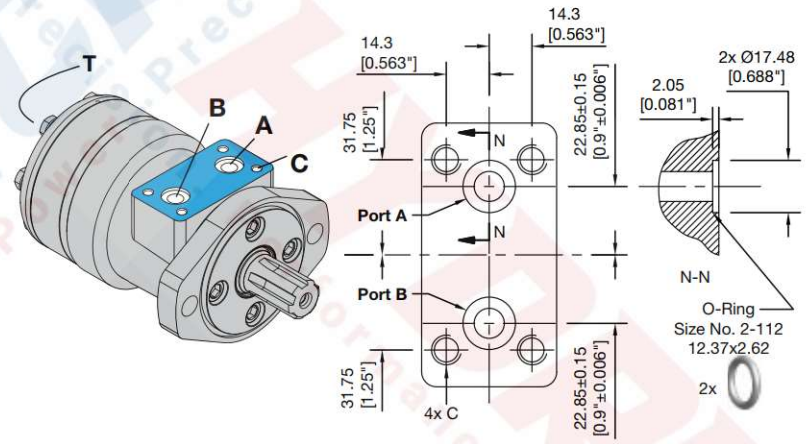
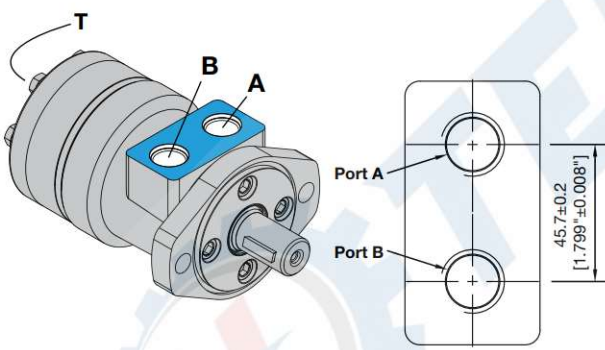

Connection	BMRS PORT CODE								
	S	P	G	R	M1	M2	M3	B4	B5
	SAE ports	NPTF ports	BSPP ports	BSPT ports	Metric ports	Metric ports	Metric ports	Manifold Mount (U)	Manifold Mount (M)
P (A,B)	7/8-14 UNF (17)	1/2-14 NPTF (15)	G 1/2 (15)	Rc 1/2" (15)	M18x1.5 (15)	M20x1.5 (15)	M22x1.5 (15)	Ø10	Ø10
T	7/16-20 UNF (12)	7/16-20 UNF (12)	G 1/4 (12)	Rc 1/4" (9.7)	M10x1 (12)	M10x1 (12)	M10x1 (12)	7/16-20 UNF (12)	G 1/4 (12)
C (4x)	-	-	-	-	-	-	-	5/16-18 UNC (13) U	M8 (13) M

S : SAE straight thread (O-Ring Boss) **R** : BSPT (British Standard Pipe Taper) Rc thread
P : NPTF (National Pipe Tapered Fuel) **M1, M2, M3** : Metric port
G : BSPP (British Standard Pipe Parallel) G thread

(Depth in mm)

BMRS MOUNTING FLANGE **CODE H2**

2-Bolt, SAE A Mount

- Pilot Diameter: 3.25"
- Bolt Circle Diameter: 4.19"

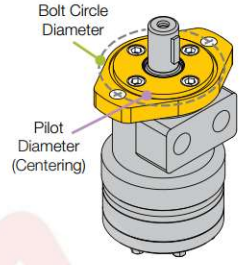
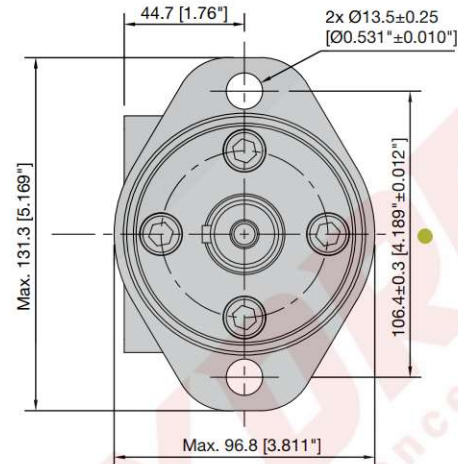
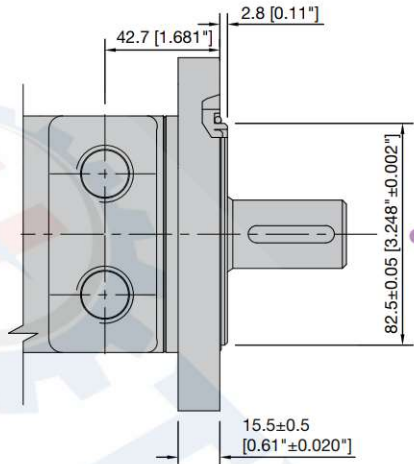

BMRS MOUNTING FLANGE **CODE H6**

4-Bolt, Magneto Mount

- Pilot Diameter: 3.25"
- Bolt Circle Diameter: 4.19"

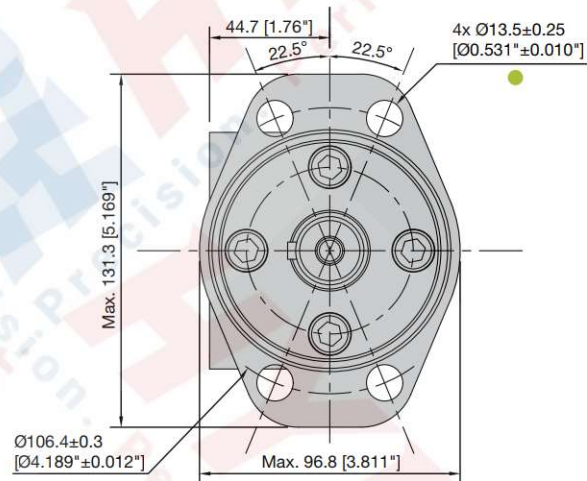
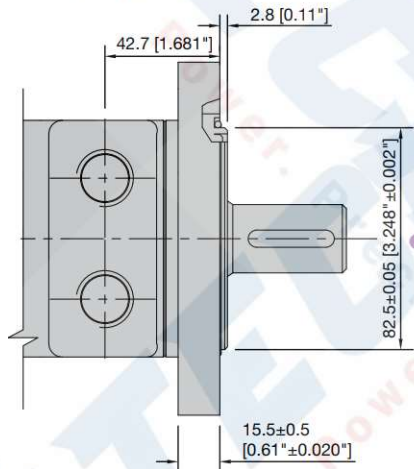

BMRS MOUNTING FLANGE **CODE H4** **CODE H5**

4-Bolt, Square Mount

- Pilot Diameter: 1.75"
- Bolt Circle Diameter: 3.25"

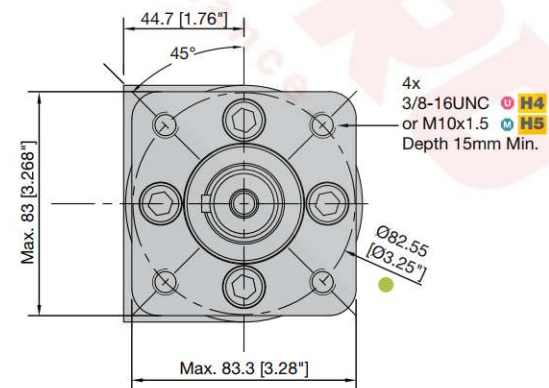
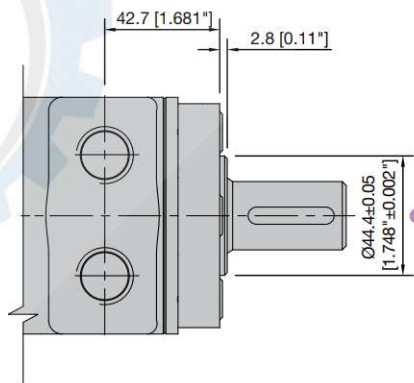

BMR SHAFT EXTENSIONS

IMPORTANT:

Ensure that the torque rating of your motor does not exceed shaft torque limitations stated below. Please refer to performance data charts.

BMR SHAFT EXTENSION **C**

1" Straight Keyed

Parallel key 1/4"x1/4"x1 1/4"

Max. Torque
290 lbf.ft [395 Nm]

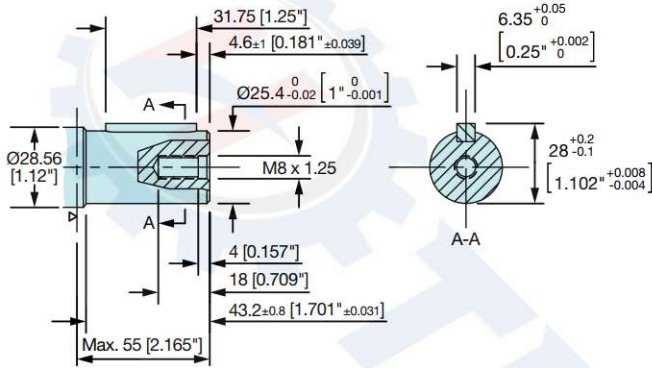

BMR SHAFT EXTENSION **R**

1" Straight Keyed

Parallel key 1/4"x1/4"x1 1/4"

Max. Torque
290 lbf.ft [395 Nm]

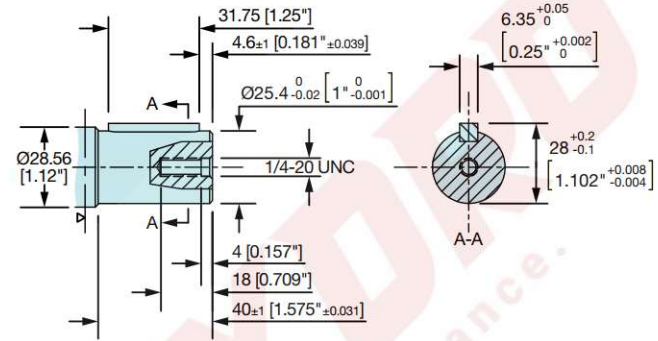

BMR SHAFT EXTENSION **G**

1 1/4" Straight Keyed

Parallel key 5/16"x5/16"x1 1/4"

Max. Torque
568 lbf.ft [770 Nm]

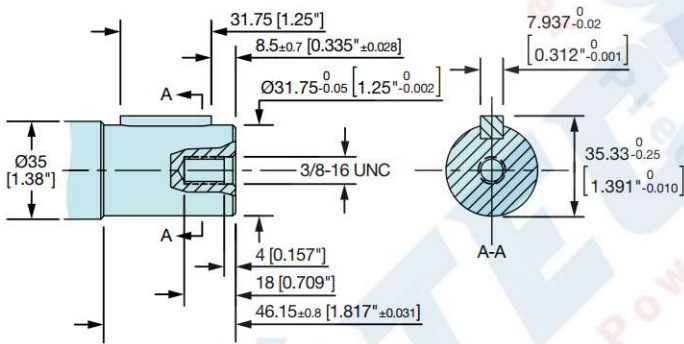

BMR SHAFT EXTENSION **A**

25 mm Straight Keyed

Parallel key 8x7x32

Max. Torque
290 lbf.ft [395 Nm]

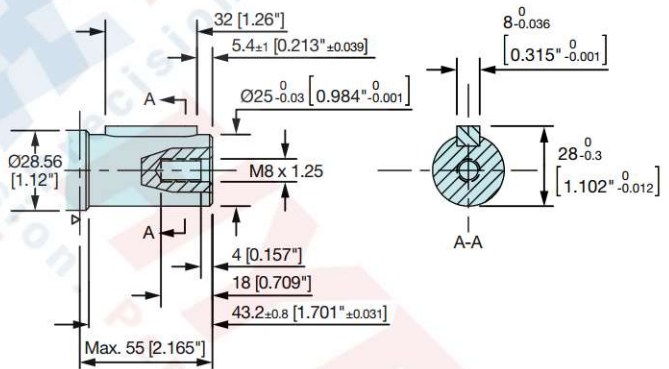

BMR SHAFT EXTENSION **B**

32 mm Straight Keyed

Parallel key 10x8x45

Max. Torque
568 lbf.ft [770 Nm]

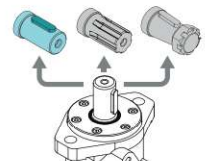
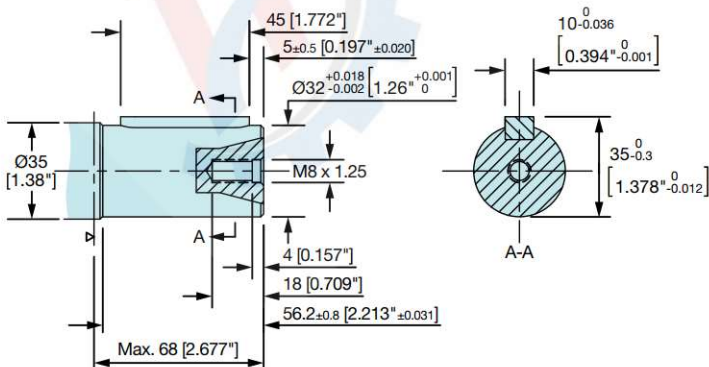

BMR SHAFT EXTENSIONS (cont.)
IMPORTANT:

Ensure that the torque rating of your motor does not exceed shaft torque limitations stated below. Please refer to performance data charts.

BMR SHAFT EXTENSION **E** 

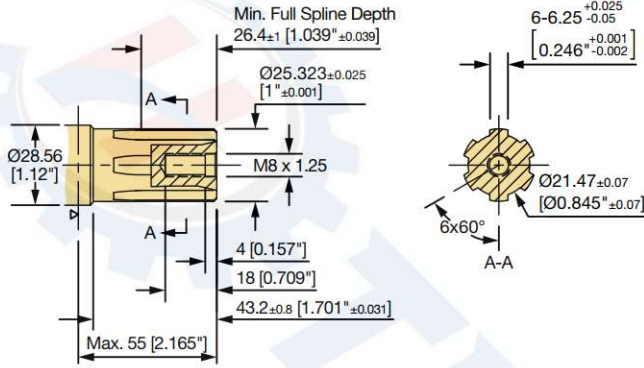
1" SAE 6B Splined
Max. Torque
 290 lbf.ft [395 Nm]

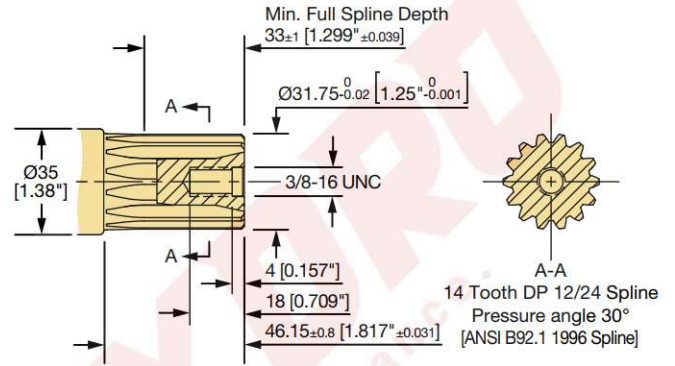
BMR SHAFT EXTENSION **F** 

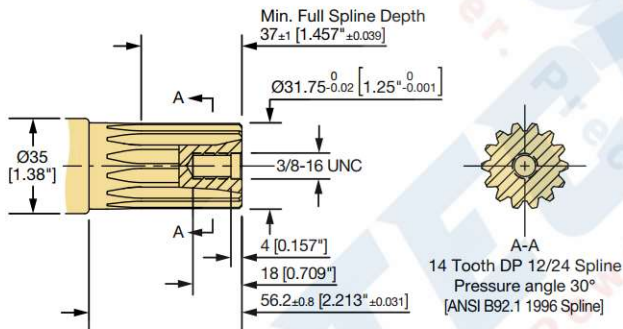
1 1/4" 14 Tooth Splined
Max. Torque
 568 lbf.ft [770 Nm]

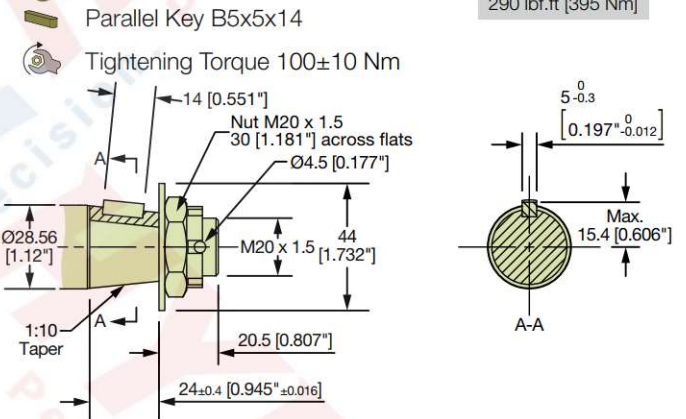
BMR SHAFT EXTENSION **FD** 

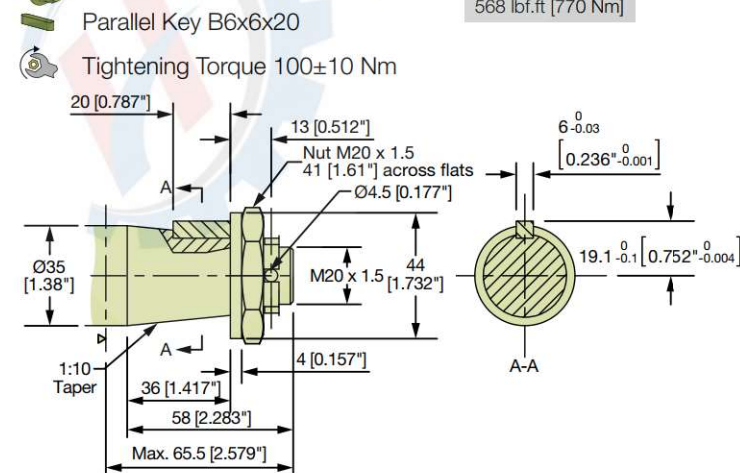
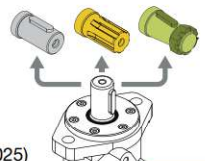
1 1/4" 14 Tooth Splined (Ext.)
Max. Torque
 568 lbf.ft [770 Nm]

BMR SHAFT EXTENSION **T** 

28.56 mm Tapered (1:10) w/ Nut
Max. Torque
 290 lbf.ft [395 Nm]

BMR SHAFT EXTENSION **T1** 

35 mm Tapered (1:10) w/ Nut
Max. Torque
 568 lbf.ft [770 Nm]

 mm [Inch]
 Imperial  Metric

BMRS SHAFT EXTENSIONS

IMPORTANT:

Ensure that the torque rating of your motor does not exceed shaft torque limitations stated below. Please refer to performance data charts.

BMRS SHAFT EXTENSION **D** 

 **7/8" Straight Keyed**
 Parallel key 1/4"x1/4"x1"

Max. Torque
265 lbf.ft [360 Nm]

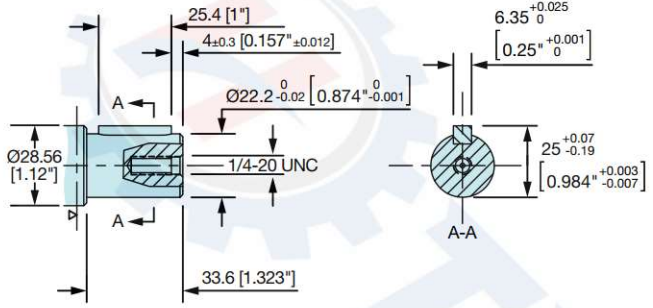

BMRS SHAFT EXTENSION **K** 

 **1" Straight Keyed**
 Woodruff key 1/4"x1"

Max. Torque
290 lbf.ft [395 Nm]

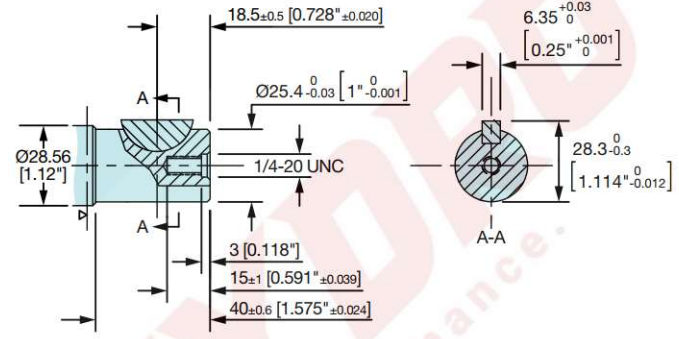

BMRS SHAFT EXTENSION **R** 

 **1" Straight Keyed**
 Parallel key 1/4"x1/4"x1 1/4"

Max. Torque
290 lbf.ft [395 Nm]

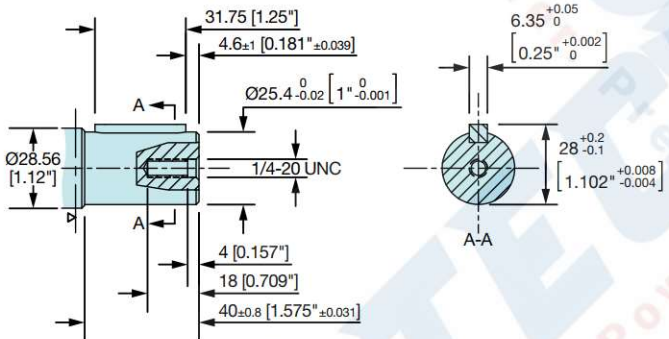

BMRS SHAFT EXTENSION **J** 

 **25 mm Straight Keyed**
 Parallel key Ø7x7x32

Max. Torque
290 lbf.ft [395 Nm]

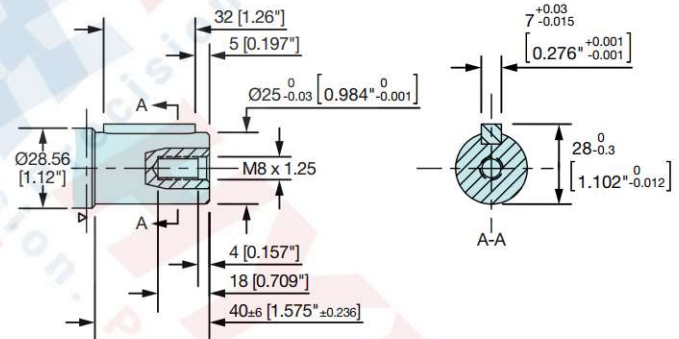



BMRS SHAFT EXTENSION **P** 

 **25 mm Straight Keyed**
 Parallel key 8x7x28

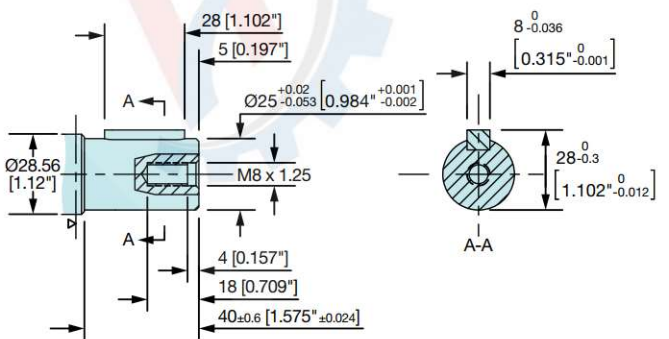
Max. Torque
290 lbf.ft [395 Nm]



BMRS SHAFT EXTENSION **A** 

 **25 mm Straight Keyed**
 Parallel key 8x7x32

Max. Torque
290 lbf.ft [395 Nm]

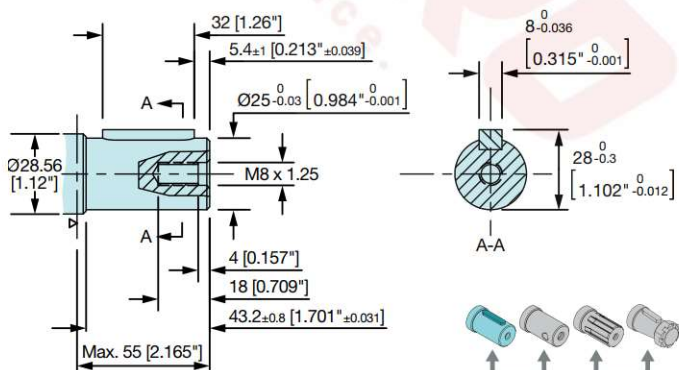

BMRS SHAFT EXTENSIONS (cont.)
IMPORTANT:

Ensure that the torque rating of your motor does not exceed shaft torque limitations stated below. Please refer to performance data charts.

BMRS SHAFT EXTENSION
CODE
H1

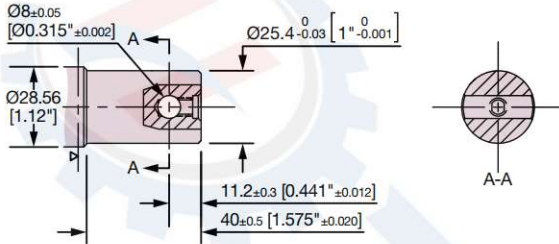
1" Straight w/ .315 Crosshole
Max. Torque
 147.5 lbf.ft [200 Nm]

* H1 shaft can also be ordered on the BMR model.

BMRS SHAFT EXTENSION
CODE
H5

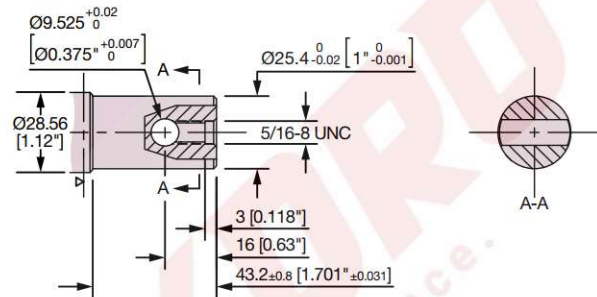
1" Straight w/ .375 Crosshole
Max. Torque
 147.5 lbf.ft [200 Nm]

* H5 shaft can also be ordered on the BMR model.

BMRS SHAFT EXTENSION
CODE
H

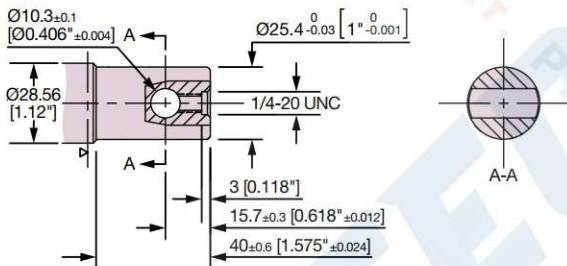
1" Straight w/ .406 Crosshole
Max. Torque
 147.5 lbf.ft [200 Nm]

* H shaft can also be ordered on the BMR model.

BMRS SHAFT EXTENSION
CODE
I

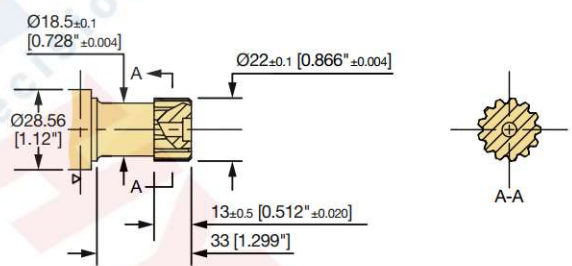
7/8" SAE B 13T Splined
Max. Torque
 125 lbf.ft [170 Nm]

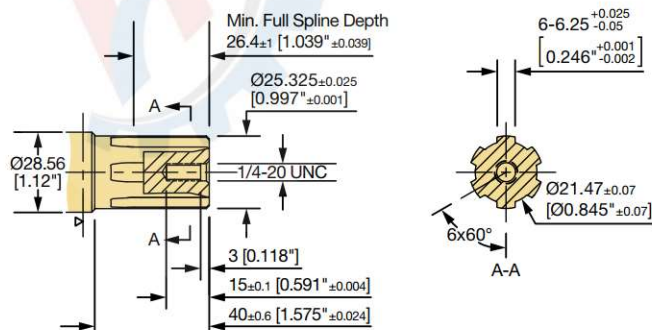
BMRS SHAFT EXTENSION
CODE
S

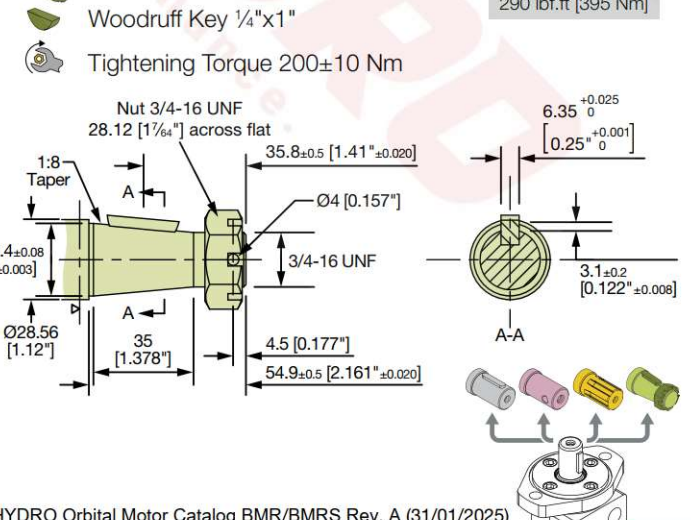
1" SAE 6B Splined
Max. Torque
 290 lbf.ft [395 Nm]

BMRS SHAFT EXTENSION
CODE
T2

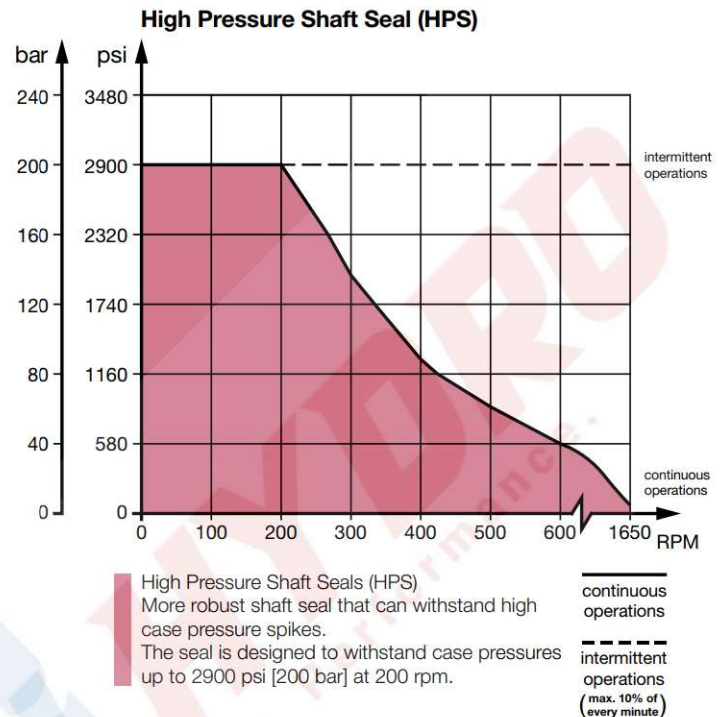
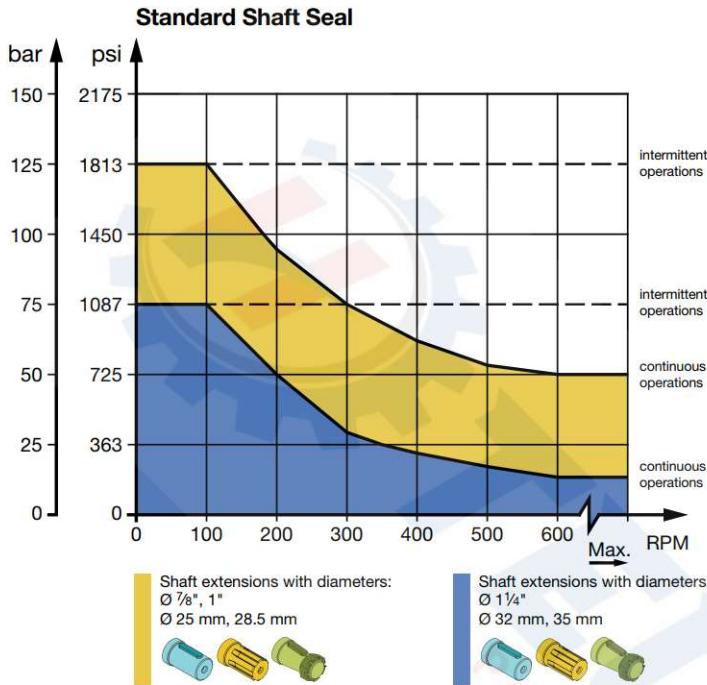
1" Tapered (1:8) w/ Nut
Max. Torque
 290 lbf.ft [395 Nm]

 mm [Inch]
 Imperial  Metric

PERMISSIBLE SHAFT SEAL PRESSURES - BMR, BMRS MODELS



Internal Drain, Permissible back pressure and case pressure:

The internal drain option is standard on all BMR, BMRS, BMRWN series motors. There are Built-In Check Valves integrated in the housing of the motor that connect the case area of the motor to each of the work ports (A and B). During normal operation, pressure in the input and return lines of the motor close the corresponding check valves. However, when the pressure in the motor case becomes greater than that of the return line, the check valve between the case and low pressure return line opens, allowing the case leakage to flow into the return line. Since the operation of the check valves is dependent upon a pressure differential, the internal drain option operates in either direction of motor rotation and whichever work port (A or B) has the lower pressure. This offers versatility and increased shaft seal life as the drain line relieves the pressure on the shaft seal to tank.¹⁾

Schematic 1 - External Drain

With case drain port used, the shaft seal pressure = pressure at drain.

Schematic 2 - Internal Drain

With case drain port not in use, the shaft seal pressure = pressure at the return line.

Schematic 1 External Drain

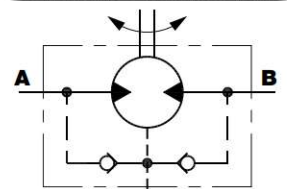

Drain
CASE PRESSURE DRAINED TO TANK
Shaft Seal Pressure = Pressure at Drain

Schematic 2 Internal Drain

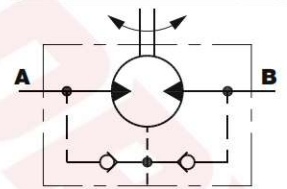

Drain (Plugged)
CASE PRESSURE DRAINED INTERNALLY
Shaft Seal Pressure = Pressure at Return Line

Important:

1) Installing motors with "internal drainage" in series or when the motor operates in a meter-out circuit is not recommended unless overall pressure drop over all motors is below the maximum allowable backpressure.

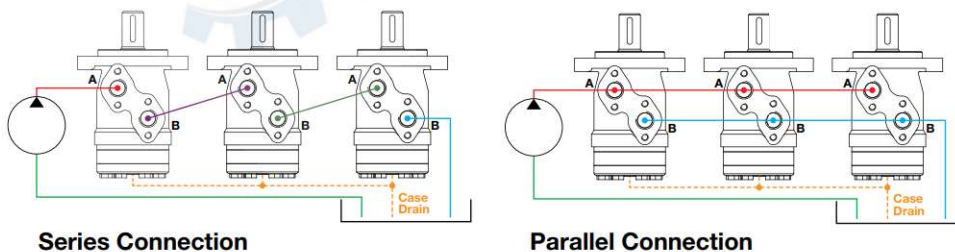

Oil Flow In Drain Line

The table shows the Max. oil flow in the drain line at a return pressure less than 72-145 psi (5-10 bar)

Pressure Drop psi (bar)	Viscosity mm ² /s	Oil Flow in the Drain Line gpm (l/min)
1450 (100)	20	0.66 (2.5)
	35	0.48 (1.8)
2030 (140)	20	0.93 (3.5)
	35	0.75 (2.8)

DIRECTION OF SHAFT ROTATION - BMR, BMRS, BMRWN, BMR(S)-BK01 SERIES

Standard Rotation

(Viewed from Shaft End)

Port **A** Pressurized - **CW**

Port **B** Pressurized - **CCW**

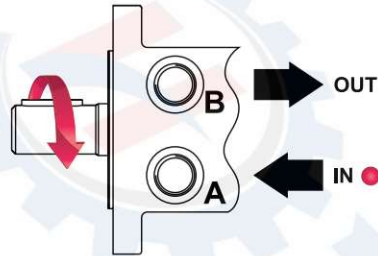

Reverse Rotation

(Viewed from Shaft End)

Port **A** Pressurized - **CCW**



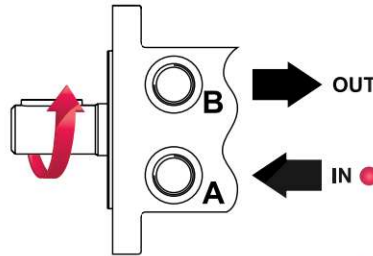



Port **B** Pressurized - **CW**

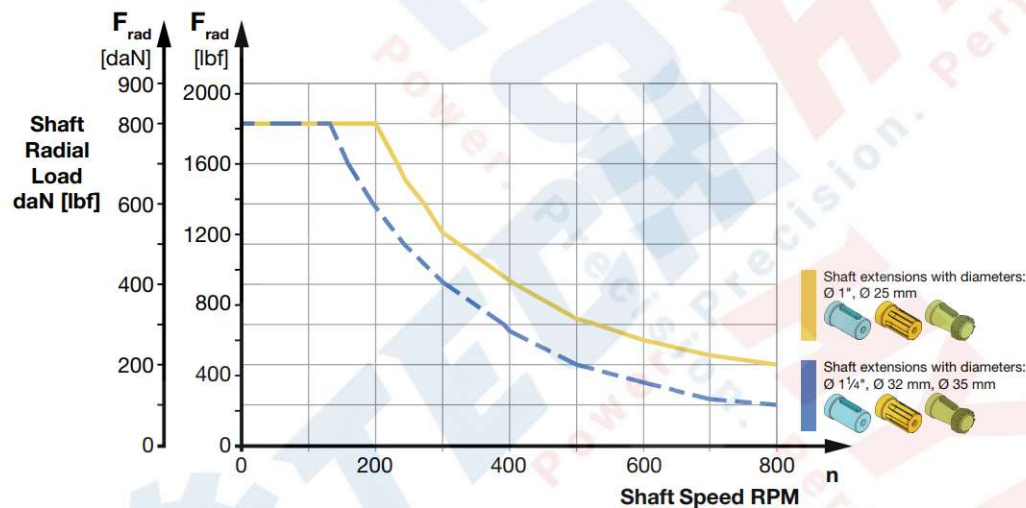

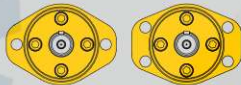
PERMISSIBLE SHAFT LOADS FOR BMR AND BMRS MOTORS

The permissible radial shaft load F_{rad} depends on the speed (rpm), distance from the point of load to the mounting flange and shaft version. The curve shows the relation between F_{rad} and speed (rpm) on the standard motor with journal (slide) bearing.



Mounting Flange	Oval Mounts		Square Mount
	 L = 30 mm [1.18 in]		 L = 24 mm [0.94 in]
Shaft Extension	Shaft extensions with diameters: Ø 1", Ø 25 mm, Ø 28.5 mm 	Shaft extensions with diameters: Ø 1 1/4", Ø 32 mm, Ø 35 mm 	Shaft extensions with diameters: Ø 1", Ø 25 mm, Ø 28.5 mm 
F_{rad} Radial Shaft Load (side load)	lbf^*  formula	$\frac{800}{n} \times \frac{2215}{3.74+L}$	$\frac{800}{n} \times \frac{1660}{3.74+L}$
	daN^*  formula	$\frac{800}{n} \times \frac{25000}{95+L}$	$\frac{800}{n} \times \frac{18750}{95+L}$
		$\frac{800}{n} \times \frac{2215}{3.98+L}$	$\frac{800}{n} \times \frac{25000}{101+L}$

* $n < 200$ RPM; max $F_{rad} = 1800$ lbs [800 daN]
 $n \geq 200$ RPM; $L < 2.2$ in [55 mm]
 1 Dekanewton [daN] = 2.248 Pound-force [lbf]

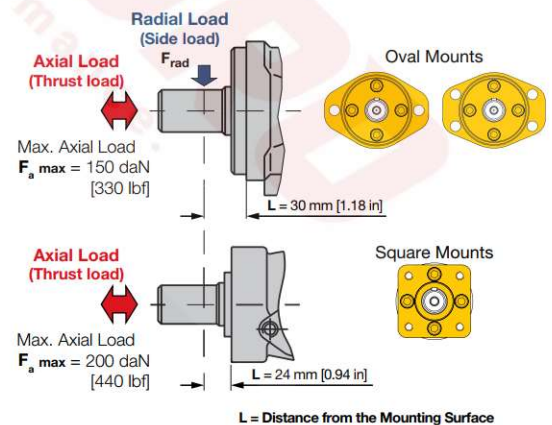

BMR DESIGNATION & ORDERING CODE

BMR - ... - 200 - 2 - C - S - ... - ... - ... - HPS



1 Series

BMR Offset Ports



2 Bearing

Omit	Standard Slide Bearings
N1	Needle Bearings ¹ (Optional)

¹N1 will be factory delivery.

3 Displacement

	cm ³ /rev	in ³ /rev
36	36	2.20
50	51.7	3.15
80	81.5	4.97
100	102	6.22
125	127.2	7.76
160	157.2	9.59
200	194.5	11.87
250	253.5	15.47
315	317.5	19.38
375	381.4	23.27
500	489	29.8

^{*}Pages 5-10 for performance details.

4 Mounting Type

2	2-Bolt, SAE A	
4	4-Bolt, Magneto	
H4	4-Bolt, Square	
H5	4-Bolt, Square	

^{*}Pages 11-12 for mounting details.

5 Output Shaft

C	1" Straight Keyed (Ext.) (1/4"x1/4"x1-1/4" key)	
R	1" Straight Keyed (1/4"x1/4"x1-1/4" key)	
G	1 1/4" Straight Keyed (5/16"x5/16"x1-1/4" key)	
A	25 mm Straight Keyed (8x7x32 key)	
B	32 mm Straight Keyed (10x8x45 key)	
E	1" SAE 6B Splined	
F	1 1/4" 14 Tooth Splined	
FD	1 1/4" 14 Tooth Splined (Ext.)	
T	28.56 mm Tapered (1:10)	
T1	35 mm Tapered (1:8)	

^{*}Pages 15-16 for shaft details.

9 Shaft Seal Version

HPS	High Pressure Shaft Seal ²
-----	---------------------------------------

8 Options

Omit	None
0	No Case Drain
F	Free Running Rotor ³
LS	Low Speed Valve ⁴

^{*}Contact Techhydro if option required is not listed.

7 Rotation

Omit	Standard Rotation
R	Reverse Rotation

^{*}Page 20 for rotation details.

6 Ports (A&B,T)

S	SAE Ports (-10,-4)	
P	NPTF Ports (1/2,-4)	
D	BSPP Ports (G1/2,G1/4)	
R	BSPT Ports (Rc1/2,Rc1/4)	
M	Metric Ports (M22,M14)	

^{*}Page 11 for port details.

Techhydro "standard" series motors are painted black and "J" series motors are painted industrial gray.

- Needle Bearing:** Techhydro standard BMR and BMRS motors have the slide bearing. For shafts supported by needle bearings use the N1 code (e.g., BMR-N1, BMRS-N1). Motors with needle bearings are suitable for operating conditions such as frequent start and stops, vibration on the shaft, high static and dynamic radial loads in short operating terms.
- High Pressure Shaft Seal:** The high pressure shaft seals allow the motors to withstand high case pressures at high speeds without external drain line.
- Free Running Rotors:** The Free Running Rotor Set has increased clearance in all friction parts, allowing the shaft to rotate more freely with less mechanical drag. The increased clearance also improves lubrication of the wear surfaces of gear set and friction parts. Additional advantages of "F" version are prolonging of the life of the hydraulic motors at high speeds, as well as the possibility to use them in systems with wide variation of the loading. "F" version motors are designed to operate with high speed (typically over 300 rpm) and low pressure drop. Volumetric efficiency may be reduced slightly due to increased clearances.
- Low Speed Motors:** Low speed valve feature optimizes the motor for low-speed performance. Motors with this valving provide very low speed while maintaining high torque. They are designed to run continuously at low speed (typically up to 200 rpm) and normal pressure drop and reduced flow. Optimal run is guaranteed at speeds of 20 to 50 rpm. Motors with this valving have an increased starting pressure and are not recommended for use at pressure drop less than 580 psi (40 bar).
TECHYDRO Orbital Motor Catalog BMR/BMRS Rev. A (31/01/2025)

Imperial Metric

BMRS DESIGNATION & ORDERING CODE
BMRS - ... - 200 - H2 - K - S - ... - ... - ... - HPS

1 Series

BMRS Aligned Ports



2 Bearing

Omit	Standard Slide Bearings
N1	Needle Bearings ¹ (Optional)





*N1 will be factory delivery.

3 Displacement

	cm ³ /rev	in ³ /rev
36	36	2.20
50	51.7	3.15
80	81.5	4.97
100	102	6.22
125	127.2	7.76
160	157.2	9.59
200	194.5	11.87
250	253.5	15.47
315	317.5	19.38
375	381.4	23.27













*Pages 5-10 for performance details.

4 Mounting Type

H2	2-Bolt, SAE A	
H6	4-Bolt, Magneto	
H4	4-Bolt, Square	
H5	4-Bolt, Square	

*Pages 13-14 for mounting details.

5 Output Shaft

D	0.875" Straight Keyed (1/4"x1/4"x1" key)	
K	1" Straight Keyed (1/4"x1" Woodruff key)	
R	1" Straight Keyed (1/4"x1/4"x1-1/4" key)	
J	25 mm Straight Keyed (7x7x32 key)	
P	25 mm Straight Keyed (8x7x28 key)	
A	25 mm Straight Keyed (8x7x32 key)	
H1	1" Straight w/ .315 Crosshole	
H5	1" Straight w/ .375 Crosshole	
H	1" Straight w/ .406 Crosshole	
I	0.875" SAE B 13T Splined	
S	1" SAE 6B Splined	
T2	28.56 mm Tapered (1:10)	

*Pages 17-18 for shaft details.

9 Shaft Seal Version

HPS	High Pressure Shaft Seal ²
-----	---------------------------------------

8 Options

Omit	None
0	No Case Drain
F	Free Running Rotor ³
LS	Low Speed Valve ⁴









*Contact Techhydro if option required is not listed.

7 Rotation

Omit	Standard Rotation
R	Reverse Rotation

*Page 20 for rotation details.



6 Ports (A&B,T)

S	SAE Ports (-10,-4)	
P	NPTF Ports (1/2,-4)	
G	BSPP Ports (G1/2,G1/4)	
R	BSPT Ports (Rc1/2,Rc1/4)	
M1	Metric Ports (M18,M10)	
M2	Metric Ports (M20,M10)	
M3	Metric Ports (M22,M10)	
B4	Manifold Mount (5/16 UNC bolts,-4)	
B5	Manifold Mount (M8 bolts,G1/4)	

*Page 13 for port details.

Techhydro "standard" series motors are painted black and "J" series motors are painted industrial gray.

- Needle Bearing:** Techhydro standard BMR and BMRS motors have the slide bearing. For shafts supported by needle bearings use the N1 code (e.g., BMR-N1, BMRS-N1). Motors with needle bearings are suitable for operating conditions such as frequent start and stops, vibration on the shaft, high static and dynamic radial loads in short operating terms.
- High Pressure Shaft Seal:** The high pressure shaft seals allow the motors to withstand high case pressures at high speeds without external drain line.
- Free Running Rotors:** The Free Running Rotor Set has increased clearance in all friction parts, allowing the shaft to rotate more freely with less mechanical drag. The increased clearance also improves lubrication of the wear surfaces of gear set and friction parts. Additional advantages of "F" version are prolonging of the life of the hydraulic motors at high speeds, as well as the possibility to use them in systems with wide variation of the loading. "F" version motors are designed to operate with high speed (typically over 300 rpm) and low pressure drop. Volumetric efficiency may be reduced slightly due to increased clearances.
- Low Speed Motors:** Low speed valve feature optimizes the motor for low-speed performance. Motors with this valving provide very low speed while maintaining high torque. They are designed to run continuously at low speed (typically up to 200 rpm) and normal pressure drop and reduced flow. Optimal run is guaranteed at speeds of 20 to 50 rpm. Motors with this valving have an increased starting pressure and are not recommended for use at pressure drop less than 580 psi (40 bar).

 Imperial  Metric

BMRWN DIMENSIONS, PORT & MOUNTING DETAILS

BMRWN Wheel Motor

4-Bolt, Wheel Mount

- Pilot Diameter: 3.25"
- Bolt Circle Diameter: 5.81"

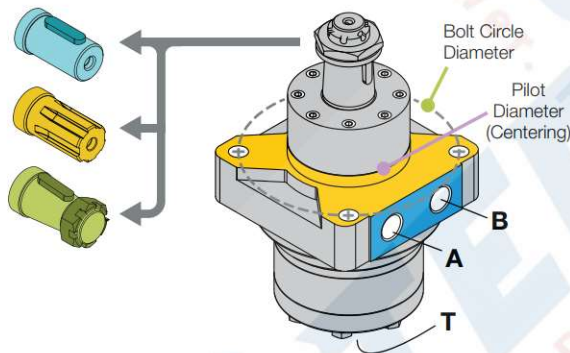
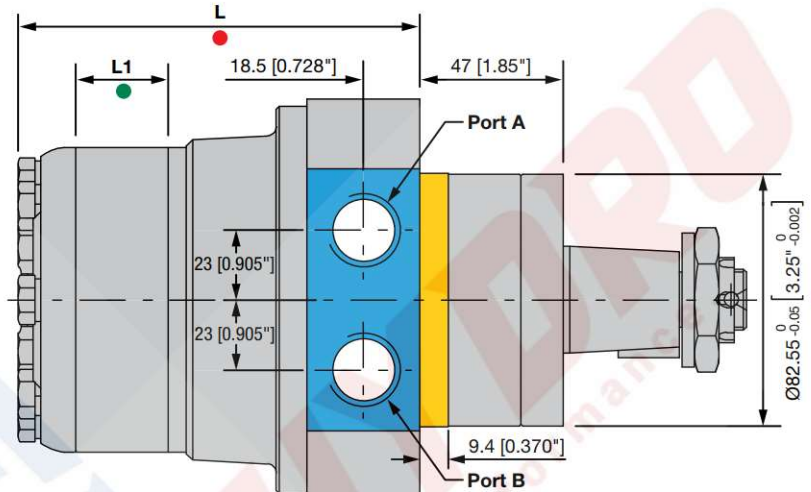
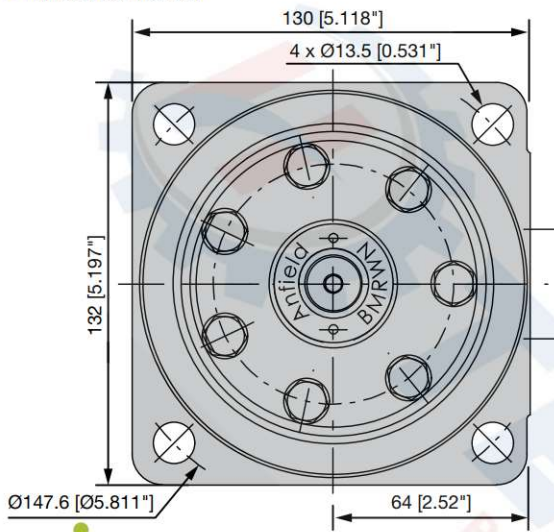

Model	GEROTOR WIDTH	
	L ●	L1 ●
BMRWN 50	113.0 [4.45"]	10.0 [0.39"]
BMRWN 80	119.0 [4.69"]	16.0 [0.63"]
BMRWN 100	123.0 [4.84"]	20.0 [0.79"]
BMRWN 125	128.0 [5.04"]	25.0 [0.98"]
BMRWN 160	133.5 [5.26"]	30.5 [1.20"]
BMRWN 200	141.0 [5.55"]	38.1 [1.50"]
BMRWN 250	153.0 [6.02"]	50.0 [1.97"]
BMRWN 315	165.0 [6.50"]	62.0 [2.44"]
BMRWN 375	126.0 [4.96"]	74.0 [2.91"]

Connection	BMRWN PORT CODE			
	S	P	G	M
P (A,B)	7/8-14 O-Ring (17)	1/2-14NPTF (15)	G 1/2 (15)	M22 x 1.5 (15) M
T	7/16-20UNF (12)	7/16-20UNF (12)	G 1/4 (12)	M14 x 1.5 (12) M

(Depth in mm)

- S** : SAE straight thread (O-Ring Boss)
- P** : NPTF (National Pipe Tapered Fuel)
- G** : BSPP (British Standard Pipe Parallel) G thread
- M** : Metric port

SHAFT EXTENSION **G** **U** IMPERIAL

1 1/4 Inch Straight Keyed

SHAFT EXTENSION **F** **U** IMPERIAL

1 1/4 Inch 14 Tooth Splined

SHAFT EXTENSION **B** **M** METRIC

32 mm Straight Keyed

SHAFT EXTENSION **FD** **U** IMPERIAL

1 1/4 Inch 14 Tooth Splined (Ext.)

SHAFT EXTENSION **T1** **M** METRIC

35 mm Tapered (1:10 w/ Nut)

*Shaft Details: pages 15-16.

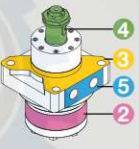
BMRWN DESIGNATION & ORDERING CODE
BMRWN - 200 - ... - T1 - S - ... - ... - HPS

1 Series

BMRWN Wheel Motor w/ Needle Bearing¹

2 Displacement

	cm ³ /rev	in ³ /rev
50	51.7	3.15
80	81.5	4.97
100	102	6.22
125	127.2	7.76
160	157.2	9.59
200	194.5	11.87
250	253.5	15.47
315	317.5	19.38
375	381.4	23.27

3 Mounting Type

Omit	Wheel Mount Pilot Ø 82.5 x 9.4
------	--------------------------------

8 Shaft Seal Version

HPS High Pressure Shaft Seal²



7 Options

Omit	None
0	No Case Drain





6 Rotation

Omit	Standard Rotation
R	Reverse Rotation

5 Ports (A&B,T)

S	SAE Ports (-10,-4)	
P	NPTF Ports (1/2,-4)	
G	BSPP Ports (G1/2,G1/4)	
M	Metric Ports (M22,M14)	

4 Output Shaft

G	1¼" Straight Keyed (5/16"x5/16"x1-1/4" key)	
B	32 mm Straight Keyed (10x8x45 key)	
F	1¼" 14 Tooth Splined	
FD	1¼" 14 Tooth Splined (Ext.)	
T1	35 mm Tapered (1:10)	

**Pages 5-10 for performance details.*

**Pages 15-16 for shaft details.*

**Page 20 for rotation details.*

**Page 23 for port details.*

Techhydro "standard" series motors are painted black and "J" series motors are painted industrial gray.

1. Needle Bearing:

The output shaft on BMRWN runs in needle bearings. These bearings and the recessed mounting flange allow a higher permissible radial load in comparison to our standard BMR motors with slide bearings. The needle bearings are capable of absorbing large radial forces. As the motors have separate axial bearings, the operating life of the needle bearings is not affected by the size of the axial load.

These types of motors are suitable for operating conditions such as frequent start and stops, vibration on the shaft, high static and dynamic radial loads in short operating terms.

2. High Pressure Shaft Seal:

The high pressure shaft seals allow the motors to withstand high case pressures at high speeds without external drain line.

BMR-BK01, BMRS-BK01, BMRWN-BK01 MOTORS WITH INTEGRATED BRAKE

DESCRIPTION & FUNCTION

BMR-BK01, BMRS-BK01 and BMRWN-BK01 models are equipped with a fail-safe friction disk brake, where in the absence of system pressure (at port C) the brake is engaged.

In normal condition where there is no pressure on the integrated brake, the brake is applied. The brake is released when hydraulic pressure of 21 bar [300psi] min. is applied to the brake release port.

- 1) This brake is to be used only as a passive parking brake. It may not be used for dynamic braking.
- 2) Brake motors must always have a drain line. The brake release pressure is the difference between the pressure in the brake release line and the pressure in the drain line.

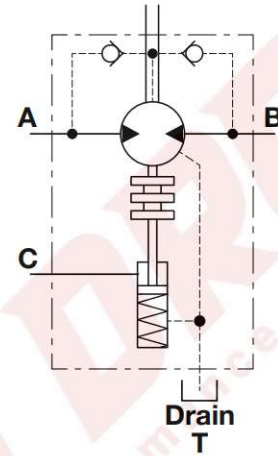

Schematic

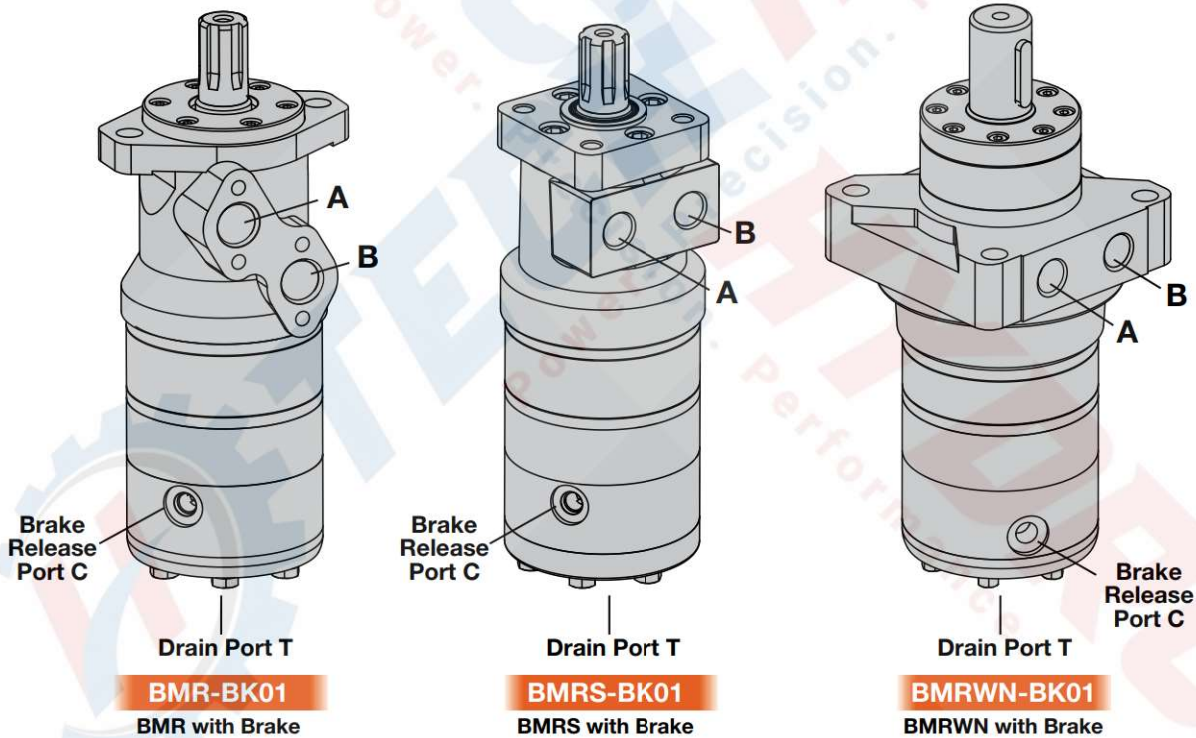

Techydro switch valve (Part no. FSR) with brake release port available for BMR-BK01 motor.

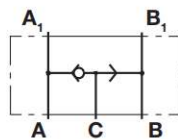

BMR-BK01, BMRS-BK01, BMRWN-BK01 DIMENSIONS, PORT & MOUNTING DETAILS

BMR-BK01

Mounting Details: Pages 11-12
 Shaft Details: Pages 15-16
 Port Details: Page 11

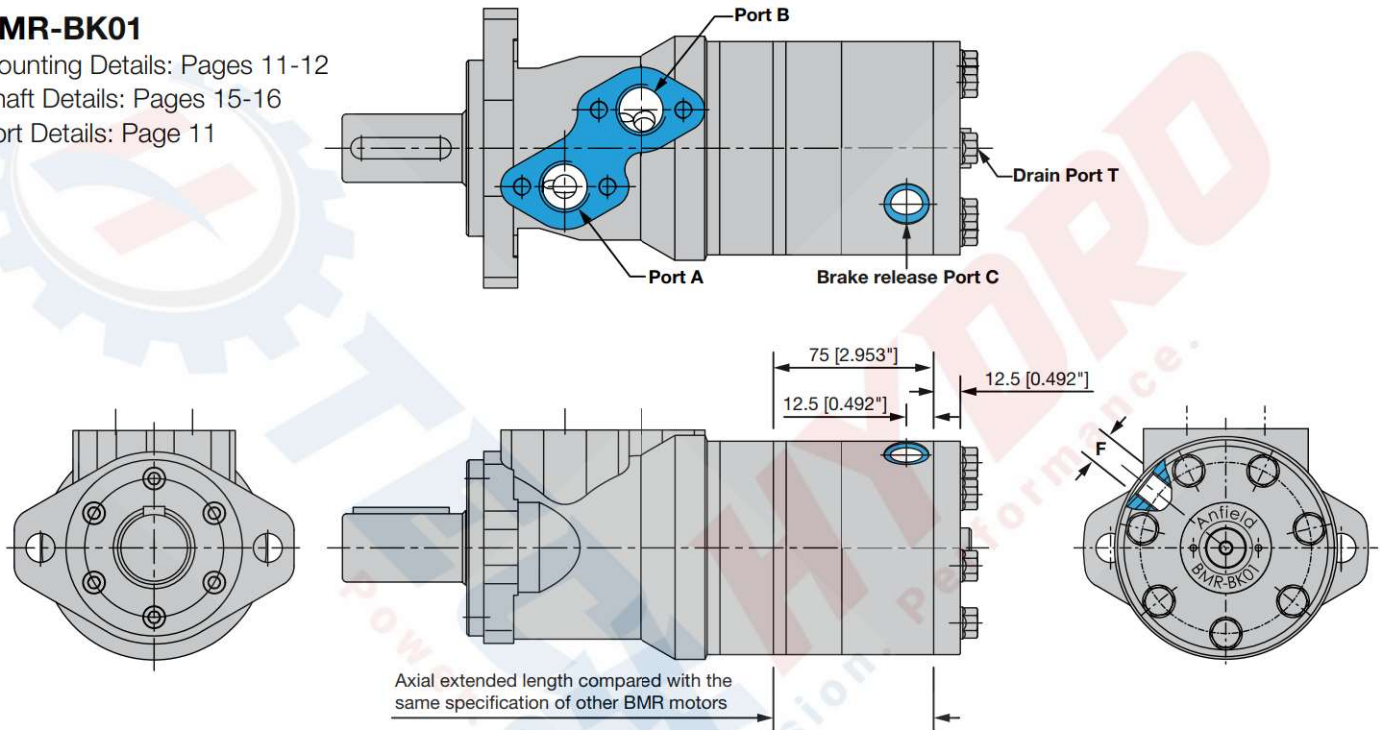

BMRS-BK01

Mounting Details: Pages 13-14
 Shaft Details: Pages 17-18
 Port Details: Page 13

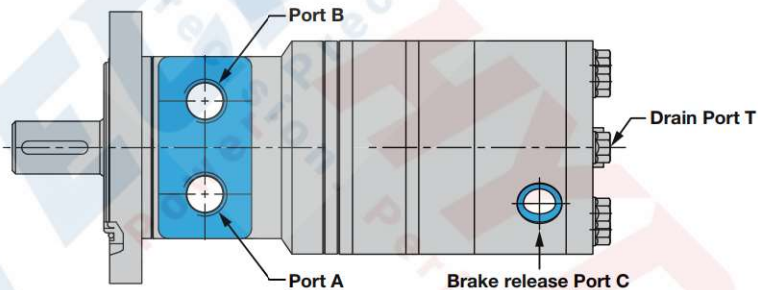

BMRWN-BK01

Mounting Details: Pages 23
 Shaft Details: Pages 15-16
 Port Details: Page 23

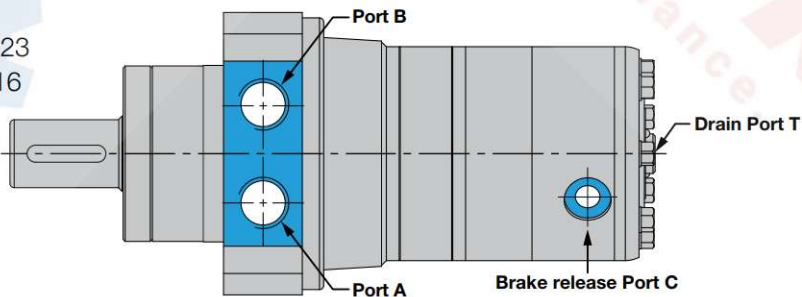



Note:

The axial extended length reduces 75mm as pictured above.
 Port C is brake releasing port; the position is as pictured above.

Port C	F
S	7/16-20 UNF Depth 9 [0.354"]
G	G1/4 Depth 9 [0.354"]

TECHNICAL SPECIFICATIONS - BMR-BK01, BMRS-BK01, BMRWN-BK01

				1	2	3	4	5	6	7	8	9
	BMR-BK01	BMRS-BK01	BMRWN-BK01	50	80	100	125	160	200	250	315	375
Geometric Displacement	in ³ /r			3.15	4.97	6.22	7.76	9.59	11.87	15.46	19.38	23.27
	cm ³ /r			51.7	81.5	102.0	127.2	157.2	194.5	253.3	317.5	381.4
Max. Speed	rpm	Rated		490	479	478	421	341	276	212	169	141
		Cont.		509	502	497	459	372	301	231	184	166
		Inter.		603	598	574	574	465	376	289	230	192
Max. Flow	gpm	Rated		6.9	10.6	13.2	14.6	14.6	14.6	14.6	14.6	14.6
				26	40	50	55	55	55	55	55	55
	l/min	Cont.		7.1	11.1	13.8	15.9	15.9	15.9	15.9	15.9	17.2
				29	42	52	60	60	60	60	60	65
	Inter.		8.5	13.2	15.9	19.8	19.8	19.8	19.8	19.8	19.8	19.8
			32	50	60	75	75	75	75	75	75	75
Max. Torque	lbf-ft	Rated		76.8	121.0	151.3	188.9	233.2	247.2	322.5	336.5	343.2
				104	164	205	256	316	335	437	456	465
	Nm	Cont.		76	149.8	187.5	233.9	288.6	264.9	322.5	336.5	343.2
				103	203	254	317	391	359	437	456	465
	Inter.		65.4	118.1	147.6	184.5	227.3	245.8	349.1	370.5	383.8	
			88.6	160	200	250	308	333	473	502	520	
Max. Output	hp	Rated		7.1	11.0	13.8	15.2	15.2	13.0	13.0	10.9	9.3
				5.3	8.2	10.3	11.3	11.3	9.7	9.7	8.1	6.9
	kW	Cont.		7.4	14.3	17.7	20.4	20.4	15.2	14.2	11.8	10.9
				5.5	10.7	13.2	15.2	15.2	11.3	10.6	8.8	8.1
	Inter.		7.5	13.4	16.1	20.1	20.1	17.6	19.2	16.2	14.1	
			5.6	10.0	12.0	15.0	15.0	13.1	14.3	12.1	10.5	
Max. Pressure Drop	Δ psi	Rated		2031	2031	2031	2031	2031	1740	1740	1450	1233
				140	140	140	140	140	120	120	100	85
	Δ bar	Cont.		2031	2538	2538	2538	2538	1885	1740	1450	1233
				140	175	175	175	175	130	120	100	85
	Inter.		2538	2901	2901	2901	2901	2538	1885	1595	1378	
			175	200	200	200	200	175	130	110	95	
Min. Release Pressure	psi (bar)			247 (17)								
Max. Inlet Pressure	Δ psi (Δ bar)			3626 (250)								
Max. Pressure in Brake Line	Δ psi (Δ bar)			3626 (250)								
Max. Static Torque of Brake (Holding Torque)	lbf-ft (Nm)			369 - 405.7 (500 - 550)								
Weight	lbs			25.8	26.2	26.2	26.9	27.6	28.7	29.8	30.9	32.0
	kg			11.7	11.9	11.9	12.2	12.5	13.0	13.5	14.0	14.5

Notes:

1. Continuous rating (Cont.): motor may be run continuously at these ratings.
2. Intermittent operation (Inter.): 10% of every minute. (6 sec.)
3. Peak: 1% of every minute. (0.6 sec.)

4. Δ Pressure: Δ psi [Δ bar] True pressure difference between inlet port and outlet port.
5. Motor Power (HP) = (Torque Output (In. lbs.) x RPM) / 63025
6. Simultaneous maximum torque & maximum speed NOT recommended and may damage the motor.

BMR-BK01 DESIGNATION & ORDERING CODE
BMR-BK01 - N1 - 200 - H4 - C - S - S - ... - ... - ... - HPS

1 Series

BMR-BK01 Offset Ports
BMR w/ integrated brake



2 Bearing

Omit	Standard Slide Bearings
N1	Needle Bearings ¹

10 Shaft Seal Version





HPS	High Pressure Shaft Seal ²
-----	---------------------------------------

3 Displacement

	cm ³ /rev	in ³ /rev
50	51.7	3.15
80	81.5	4.97
100	102	6.22
125	127.2	7.76
160	157.2	9.59
200	194.5	11.87
250	253.5	15.47
315	317.5	19.38
375	381.4	23.27









*Pages 5-10 for performance details.

4 Mounting Type

2	2-Bolt, SAE A	
4	4-Bolt, Magneto	
H4	4-Bolt, Square	
H5	4-Bolt, Square	

*Pages 11-12 for mounting details.

5 Output Shaft

C	1" Straight Keyed (Ext.) (1/4"x1/4"x1-1/4" key)	
R	1" Straight Keyed (1/4"x1/4"x1-1/4" key)	
G	1 1/4" Straight Keyed (5/16"x5/16"x1-1/4" key)	
A	25 mm Straight Keyed (8x7x32 key)	
B	32 mm Straight Keyed (10x8x45 key)	
E	1" SAE 6B Splined	
F	1 1/4" 14 Tooth Splined	
FD	1 1/4" 14 Tooth Splined (Ext.)	
T	28.56 mm Tapered (1:10)	

*Pages 15-16 for shaft details.

8 Rotation

Omit	Standard Rotation
R	Reverse Rotation



*Page 20 for rotation details.

7 Brake Release Port (C)

S	SAE Port (-4)
G	BSPP Ports (G1/4)

*Page 25 for brake release port details.

6 Ports (A&B,T)

S	SAE Ports (-10,-4)	
P	NPTF Ports (1/2,-4)	
D	BSPP Ports (G1/2,G1/4)	
R	BSPT Ports (Rc1/2,Rc1/4)	
M	Metric Ports (M22,M14)	

*Page 11 for port details.

Techydro "standard" series motors are painted black and "J" series motors are painted industrial gray.

- Needle Bearing:** BMR-BK01-N1 has an output shaft supported in needle bearing. These types of motors are more suitable for operating conditions such as frequent start and stops, vibration on the shaft, high static and dynamic radial loads in short operating terms.
- High Pressure Shaft Seal:** The high pressure shaft seals allow the motors to withstand high case pressures at high speeds without external drain line.
- Free Running Rotors:** The Free Running Rotor Set, have increased clearance in all friction parts, allowing the shaft to rotate more freely with less mechanical drag. The increased clearance also improves lubrication of the wear surfaces of gear set and friction parts. Additional advantages of "F" version are prolonging of the life of the hydraulic motors at high speeds, as well as the possibility to use them in systems with wide variation of the loading. "F" version motors are designed to operate with high speed (typically over 300 rpm) and low pressure drop. Volumetric efficiency may be reduced slightly due to increased clearances.
- Low Speed Motors:** Low speed valve feature optimizes the motor for low-speed performance. Motors with this valving provide very low speed while maintaining high torque. They are designed to run continuously at low speed (typically up to 200 rpm) and normal pressure drop and reduced flow. Optimal run is guaranteed at speeds of 20 to 50 rpm. Motors with this valving have an increased starting pressure and are not recommended for use at pressure drop less than 580 psi (40 bar).

 Imperial  Metric

BMRS-BK01 DESIGNATION & ORDERING CODE

BMRS-BK01 - N1 - 200 - H2 - K - S - S - ... - ... - ... - HPS

1 Series

BMRS-BK01 Aligned Ports
BMRS w/ integrated brake

2 Bearing

Omit	Standard Slide Bearings
N1	Needle Bearings ¹

3 Displacement

	cm ³ /rev	in ³ /rev
50	51.7	3.15
80	81.5	4.97
100	102	6.22
125	127.2	7.76
160	157.2	9.59
200	194.5	11.87
250	253.5	15.47
315	317.5	19.38
375	381.4	23.27

*Pages 5-10 for performance details.

10 Shaft Seal Version

HPS	High Pressure Shaft Seal ²
-----	---------------------------------------

9 Options

Omit	None
0	No Case Drain
F	Free Running Rotor ³
LS	Low Speed Valve ⁴

*Contact Techhydro if option required is not listed.

8 Rotation

Omit	Standard Rotation
R	Reverse Rotation

*Page 20 for rotation details.

7 Brake Release Port (C)

S	SAE Port (-4)
G	BSPP Ports (G1/4)

*Page 25 for brake release port details.

6 Ports (A&B,T)

S	SAE Ports (-10,-4)	
P	NPTF Ports (1/2,-4)	
G	BSPP Ports (G1/2,G1/4)	
R	BSPT Ports (Rc1/2,Rc1/4)	
M1	Metric Ports (M18,M10)	
M2	Metric Ports (M20,M10)	
M3	Metric Ports (M22,M10)	
B4	Manifold Mount (5/16 UNC bolts,-4)	
B5	Manifold Mount (M8 bolts,G1/4)	

*Page 13 for port details.

5 Output Shaft

D	7/8" Straight Keyed (1/4"x1/4"x1" key)	
K	1" Straight Keyed (Woodruff) (1/4"x1")	
R	1" Straight Keyed (1/4"x1/4"x1-1/4" key)	
J	25 mm Straight Keyed (7x7x32 key)	
P	25 mm Straight Keyed (8x7x28 key)	
A	25 mm Straight Keyed (8x7x32 key)	
H2	2-Bolt, SAE A	
H6	4-Bolt, Magneto	
H4	4-Bolt, Square	
H5	4-Bolt, Square	
H1	1" Straight w/ .315 Crosshole	
H	1" Straight w/ .406 Crosshole	
I	7/8" SAE B 13T Splined	
S	1" SAE 6B Splined	
T2	1" Tapered (1:8)	

*Pages 17-18 for shaft details.

Techhydro "standard" series motors are painted black and "J" series motors are painted industrial gray.

- Needle Bearing:** BMRS-BK01-N1 has an output shaft supported in needle bearing. These types of motors are more suitable for operating conditions such as frequent start and stops, vibration on the shaft, high static and dynamic radial loads in short operating terms.
- High Pressure Shaft Seal:** The high pressure shaft seals allow the motors to withstand high case pressures at high speeds without external drain line.
- Free Running Rotors:** The Free Running Rotor Set, have increased clearance in all friction parts, allowing the shaft to rotate more freely with less mechanical drag. The increased clearance also improves lubrication of the wear surfaces of gear set and friction parts. Additional advantages of "F" version are prolonging of the life of the hydraulic motors at high speeds, as well as the possibility to use them in systems with wide variation of the loading. "F" version motors are designed to operate with high speed (typically over 300 rpm) and low pressure drop. Volumetric efficiency may be reduced slightly due to increased clearances.
- Low Speed Motors:** Low speed valve feature optimizes the motor for low-speed performance. Motors with this valving provide very low speed while maintaining high torque. They are designed to run continuously at low speed (typically up to 200 rpm) and normal pressure drop and reduced flow. Optimal run is guaranteed at speeds of 20 to 50 rpm. Motors with this valving have an increased starting pressure and are not recommended for use at pressure drop less than 580 psi (40 bar).

BMRWN-BK01 DESIGNATION & ORDERING CODE
BMRWN-BK01 - 200 - ... - T1 - S - S - ... - ... - ... - HPS

1 Series

BMRWN-BK01

BMRWN Wheel Motor w/ integrated brake

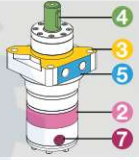

2 Displacement

	cm ³ /rev	in ³ /rev
50	51.7	3.15
80	81.5	4.97
100	102	6.22
125	127.2	7.76
160	157.2	9.59
200	194.5	11.87
250	253.5	15.47
315	317.5	19.38
375	381.4	23.27

**Pages 5-10 for performance details.*

9 Shaft Seal Version

HPS High Pressure Shaft Seal²

8 Options

Omit	None
0	No Case Drain

**Contact Techhydro if option required is not listed.*

7 Rotation

Omit	Standard Rotation
R	Reverse Rotation

**Page 20 for rotation details.*

6 Brake Release Port (C)

S	SAE Port (-4)
G	BSPP Ports (G1/4)

**Page 25 for brake release port details.*

5 Ports (A&B,T)

S	SAE Ports (-10,-4)
P	NPTF Ports (1/2,-4)
G	BSPP Ports (G1/2,G1/4)
M	Metric Ports (M22,M14)

**Page 23 for port details.*

3 Mounting Type

Omit	Wheel Mount Pilot Ø 82.5 x 9.4
------	-----------------------------------

**Pages 23 for mounting details.*

4 Output Shaft

G	1 1/4" Straight Keyed (5/16"x5/16"x1-1/4" key)
B	32 mm Straight Keyed (10x8x45 key)
F	1 1/4" 14 Tooth Splined
FD	1 1/4" 14 Tooth Splined (Ext.)
T1	35 mm Tapered (1:10)

**Pages 15-16 for shaft details.*

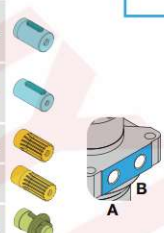

Techhydro "standard" series motors are painted black and "J" series motors are painted industrial gray.

1. Needle Bearing:

The output shaft on BMRWN-BK01 runs in needle bearings. These bearings and the recessed mounting flange allow a higher permissible radial load in comparison to our standard BMR motors with slide bearings. The needle bearings are capable of absorbing large radial forces. As the motors have separate axial bearings, the operating life of the needle bearings is not affected by the size of the axial load.

These types of motors are suitable for operating conditions such as frequent start and stops, vibration on the shaft, high static and dynamic radial loads in short operating terms.

2. High Pressure Shaft Seal:

The high pressure shaft seals allow the motors to withstand high case pressures at high speeds without external drain line.

FOR MORE INFORMATION PLEASE CONTACT US

SALES@TECHYDRO.COM.CN



TECHYDRO

☎ +86-15869517019

✉ SALES@techydro.com.cn

🌐 WWW.TECHYDRO.COM.CN

📞 whatsapp/Wechat: +86-15869517019

TEL: +86(0574) -87021030